

DENTAL

INSTRUMENTS CATALOGUE

NEW EDITION



DENTAL
DENTAL INSTRUMENTS





Perfection Surgical Ind.

Manufacturer Surgical Instruments Import & Export

 Av. Ivo Mário Isaac Pires, 4250 - Tijuco
Preto, Cotia - SP, 06720-400

 : Kingra Road Langeriali Khas
P.O Box. 1358 Sialkot
51310 Pakistan

 : +55 11 98581 7070
 : Psi Tesouras
 : psi3830

 : +92 304 2448552
 : info@perfectionsurgical.com
 : www.perfectionsurgical.com

Dear Valued Buyers

We feel immense pleasure to present our latest catalogue in which we have featured a most comprehensive range of all types of quality Surgical & Dental instruments required for day to day use for Hospital. We will be pleased to quote you a competitive Price and Delivery time.

All instruments are manufactured according to the recognized standard patterns currently in use in Hospital throughout the world and are being produced under restrict control of experts to avoid any flaw and to refrain any complaint at any stage.

A group of very vast experienced persons in manufacturing handling our quality Control System.

Any instruments proven defective in workmanship or material will be replaced with out charges.

We express our thanks to all our customers for the confidence they have placed us in the past. We further assure them that we will continue our best efforts to gain their confidence in the future.

We are always at your service.

01

EXTRACTING FORCEPS

Page # 01 - 28

02

ROOT ELEVATORS

Page # 29 - 48

03

**DIAGNOSTIC, PROBES, SCALERS, FILLING
& LABORATORY INSTRUMENTS**

Page # 49 - 98

04

**MAXILLOFACIAL SURGERY
INSTRUMENTS**

Page # 99 - 124

05

**ORTHODONTIC INSTRUMENTS
& PLIERS**

Page # 125 - 144

06

**DENTAL IMPLANT INSTRUMENTS
& Impression Tray**

Page # 145 - 182

07

HOLLOWWARE

Page # 183 - 191

Handle Selection For Extracting Forceps

Dear Valued Buyers if any Universal Fig. No. of Extracting Forceps not Found in our Catalogue you Can Refer the Fig. No. From These Diagram.

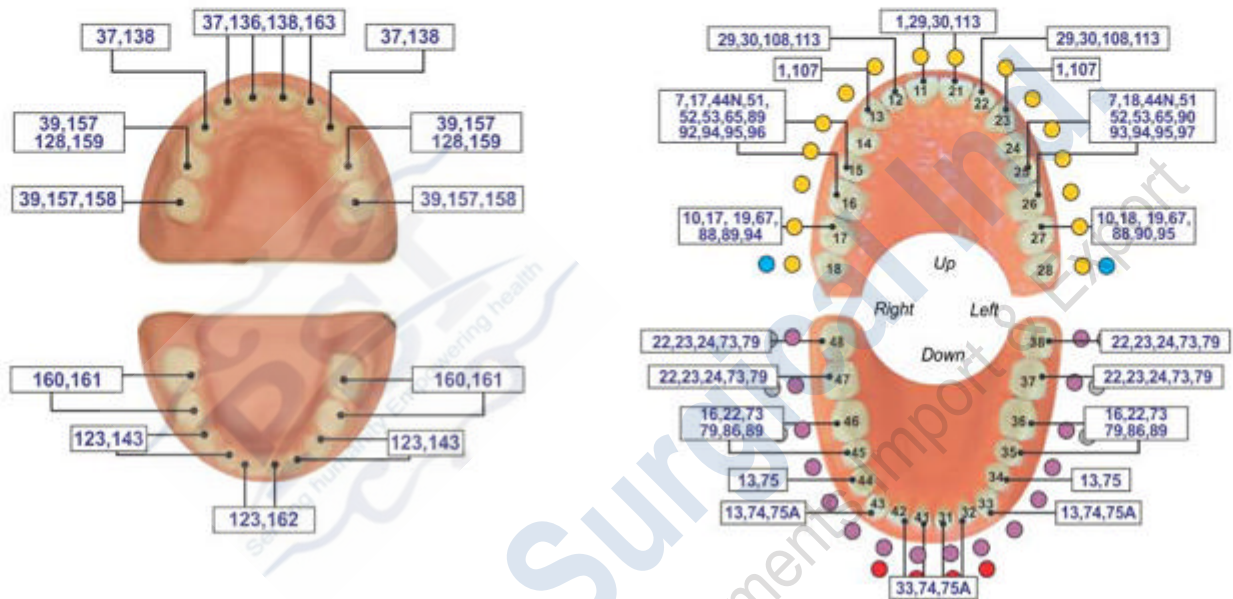

Dear Valued Buyers these are our Handle Styles



EXTRACTING FORCEPS (English Pattern)

- Щипцы экстракционные (английская форма)
- Щипці екстракційні (англійська форма)
- Forceps de Extracción (Forme Inglesa)
- استخراج الملقط (نمط اللغة الإنجليزية)
- Daviers (Forme Anglaise)
- Forceps de Extracción (Forme Inglesa)
- Zahnzangen (Englische Form)

Function: To remove teeth from bony socket



PS-1001
Fig. 1
Upper Centrals
and Canines



PS-1002
Fig. 2
Upper Laterals
and Canines



PS-1003
Fig. 4
Lower Incisors
and Canines



PS-1004
Fig. 7
Upper Premolars



PS-1005
Fig. 8
Lower Premolars



PS-1006
Fig. 13
Lower Premolars



PS-1007
Fig. 17
Upper Molars,
Right



PS-1008
Fig. 18
Upper Molars, Left



PS-1009
Fig. 21
Lower Molar



PS-1010
Fig. 22
Lower Molar



Straight extracting forceps for upper incisors and canines



Straight extracting forceps for upper incisors and canines



Straight extracting forceps for upper incisors and canines

EXTRACTING FORCEPS (English Pattern)



- Щипцы экстракционные (английская форма)
- Давиеры (Forme Anglaise)
- Zahnzangen (Englische Form)
- Щипці екстракційні (англійська форма)
- Forceps de Extracción (Forme Inglesa)
- استخراج الملقط (نمط اللغة الإنجليزية)

Function: To remove teeth from bony socket



PS-1011
18A
upper molars



PS-1012
19
upper third molars



PS-1013
20
lower third molar



PS-1014
24
lower molar, right



PS-1015
29
upper roots



PS-1016
30
Upper Roots



PS-1017
33
lower roots



PS-1018
33A
Lower Roots



PS-1019
33M
Lower roots
with long beak



PS-1020
46L



PS-1021
51
Upper Roots



PS-1022
51A
Upper Roots



Straight extracting forceps for upper incisors and canines



Straight extracting forceps for upper incisors and canines



Straight extracting forceps for upper incisors and canines

EXTRACTING FORCEPS (English Pattern)

- Щипцы экстракционные (английская форма)
- Щипці екстракційні (англійська форма)
- Daviers (Forme Anglaise)
- Forceps de Extracción (Forme Inglesa)
- Zahnzangen (Englische Form)
- استخراج الملقط (نمط اللغة الإنجليزية)

Function: To remove teeth from bony socket

WISDOM EXTRACTING FORCEPS



PS-1023
Routerier
(# 22 ½ L)
lower molars and
wisdoms, left



PS-1024
Routerier
(# 22 ½ R)
lower molars and
wisdoms, right



PS-1025
Routerier
(# 33 ½ L)
lower molar and
wisdom roots, left



PS-1026
Routerier
(# 33 ½ R)
lower molar and
wisdom roots, right



Routerier extracting forceps for lower molars and third molars, right



PS-1027
Fig. 186L
lower molars



PS-1028
Fig. 186R
lower molars



PS-1029
51AL



PS-1030
67
Upper Third Molars



PS-1031
67A
Upper Third Molars



PS-1032
79
Lower Third Molars



Angled extracting forceps for upper roots

EXTRACTING FORCEPS (English Pattern)



- Щипцы экстракционные (английская форма)
- Шипці екстракційні (англійська форма)
- Forceps de Extracción (Forme Inglesa)
- استخراج الملقط (تمط اللغة الإنجليزية)
- Daviers (Forme Anglaise)
- Zahnzangen (Englische Form)



PS-1033
73
Lower Molars



PS-1034
73 A
lower molars

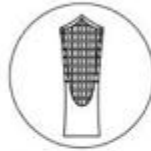

PS-1035
73 S



PS-1036
74
Lower Roots



PS-1037
74N
Lower Roots



PS-1038
75
Lower Premolars



PS-1039
86A
Lower Molars



PS-1040
86B
lower molars



PS-1041
86C
lower molars



PS-1042
87
Lower Molars



PS-1043
89
Upper Molars,
Right



PS-1044
90
Upper Molars,
Left



Straight extracting forceps for upper incisors and canines



Straight extracting forceps for upper incisors and canines



Straight extracting forceps for upper incisors and canines

EXTRACTING FORCEPS (English Pattern)

- Щипцы экстракционные (английская форма)
- Daviers (Forme Anglaise)
- Zahnzangen (Englische Form)
- Щипці екстракційні (англійська форма)
- Forceps de Extracción (Forme Inglesa)
- استخراج الملقط (نمط اللغة الإنجليزية)

DE-TRAUMATIC EXTRACTION

Improved tapered beaks for complete root contact. Cross serrations. Deep Gripe Extracting Forceps



- No Fracture
- No Tissue Damage
- Extraction With Easy



Thin Tip

**PS-1045
34**
Upper incisors and
premolars
deep-gripping



Wide Tip

**PS-1046
34A**
Upper centrals / cains
deep-gripping



Thin Tip

**PS-1047
Fig. 35**
upper permolars
deep-gripping



Wide Tip

**PS-1048
35A**
Upper incisors and
premolars
deep-gripping



Thin Tip

**PS-1049
36**
Lower premolars
deep-gripping



Wide Tip

**PS-1050
36A**
Lower premolars
deep-gripping



**PS-1051
336**
lower permolars
deep-gripping



**PS-1052
F-7C**
lower molar



**PS-1053
9**
Apex Forceps Lower Universal
Deep Root Pick



**PS-1054
79N**
Lower third molars
deep-gripping



**PS-1055
79**
Lower Third Molars



Function:

Extraction forceps are used to further loosen teeth by rotational and tilting movements and finally to extract the teeth in combination with a fulcrum.

EXTRACTING FORCEPS (English Pattern)



- Щипцы экстракционные (английская форма)
- Давиеры (Forme Anglaise)
- Zahnzangen (Englische Form)
- Щипці екстракційні (англійська форма)
- Forceps de Extracción (Forme Inglesa)
- استخراج الملقط (نمط اللغة الإنجليزية)

DEEP ROOT PICK FORCEPS



PS-1056
146
Apex Forceps Lower Root
Deep Root Pick



PS-1057
153
Apex Forceps Upper Root
Deep Root Pick



PS-1058
149
Apex Forceps Upper Root
Deep Root Pick



PS-1059
Fig. 44



PS-1060
Fig. 44Z



PS-1061
Fig. 45Z



PS-1062
46XL
Apex Forceps Lower Root
Deep Root Pick



PS-1063
67
Upper Third Molars

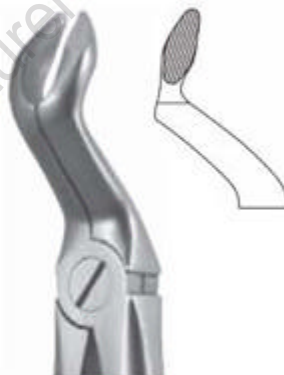

PS-1064
67A
Upper Third Molars



PS-1065
67N
Lower third molars
deep-gripping



PS-1066
331
upper roots
deep-gripping



forceps for upper incisors, premolars and roots



EXTRACTING FORCEPS (English Pattern)

- Щипцы экстракционные (английская форма)
- Daviers (Forme Anglaise)
- Zahnzangen (Englische Form)

- Щипці екстракційні (англійська форма)
- Forceps de Extracción (Forme Inglesa)
- استخراج الملقط (نمط اللغة الإنجليزية)



Fig. 1
upper
laterals
and canines



PS-1067
Set of 10 Pieces
Fig. 1
Fig. 7
Fig. 13
Fig. 17
Fig. 18
Fig. 22
Fig. 51A
Fig. 67
Fig. 74N
Fig. 79

Fig. 7
upper premolars



Fig. 13
lower premolars



Fig. 17
upper molars, right



Fig. 18
upper molars, left



Fig. 22
lower roots



Fig. 51A
upper roots



Fig. 67
upper third molars



Fig. 74N
lower molar



Fig. 79
lower third molars



Extracting forceps for upper roots



EXTRACTING FORCEPS



- Щипцы экстракционные
 - Daviers
 - Zahnzangen
- Щипці екстракційні
 - Forceps de Extracción
 - استخراج المنقظ

Pediatric Tooth Extracting Forceps Set



PS-1068
English Pattern Klein #51S
Pedodontic Upper root



PS-1069
English Pattern Klein #137
Pedodontic, Upper Incisors Spring handle



PS-1070
English Pattern Klein #5
Pedodontic Lower Incisors.



PS-1071
English Pattern Klein #139
Pedodontic Upper Premolars



Baby Tooth Extraction Forceps

PS-1072
Fig. # 01 to 07
Set of 7 Pieces



PS-1073
English Pattern Klein #7
Pedodontic Lower Roots,



PS-1074
English Pattern Klein #3
Pedodontic Upper Molars Universal

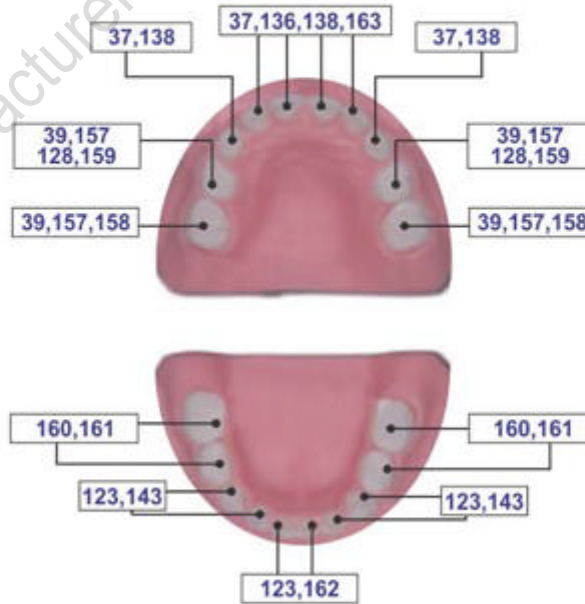

PS-1075
English Pattern Klein #6
Pedodontic Lower Molars, Spring Handle

ROOT FRAGMENT FORCEPS



Witzel
PS-1076
170mm
Upper roots, Universal



Witzel
PS-1077
165mm
Lower roots, Universal



PS-1078
#400(300)
165mm
Upper roots, Universal



PS-1079
#401(301)
160mm
Lower roots, Universal



PS-1080
Witzel Forceps With Gold
Set of 3 Pcs



PS-1081
Witzel Forceps With Hole And Screw Pattern
Set of 3 Pcs



PS-1082
Witzel Forceps With Anatomical Handle
Set of 3 Pcs



PS-1083
#401(301)
160mm
Lower roots, Universal



PS-1084
#401(301)
160mm
Lower roots, Universal



PS-1085
#401(301)
160mm
Lower roots, Universal



PS-1086
#400(300)
165mm
Upper roots, Universal



PS-1087
#400(300)
165mm
Upper roots, Universal



PS-1088
#400(300)
165mm
Upper roots, Universal



Witzel
PS-1089
165mm
Lower roots, Universal



Witzel
PS-1090
165mm
Lower roots, Universal



Witzel
PS-1091
165mm
Lower roots, Universal

ROOTS SPLINTER FORCEPS



- Щипцы для удаления корневых осколков
- Pincas Fragments
- Wurzelsplitterzangen
- Щипці для видалення корневих осколків
- Pinzas Para Fragmentos
- جنور منشقة الملظ



PS-1092
Splinter Forceps
15.5cm



Stieglitz Root Splinter Forceps



PS-1093
Splinter Forceps
15.5cm 45°



PS-1094
Stieglitz
Root Fragments



PS-1095
Stieglitz
Root Fragments



PS-1096
Stieglitz Splinter Forceps
140mm 90°



PS-1097
Stieglitz Splinter Forceps
140mm Straight

ROOT FRAGMENT FORCEPS



PS-1098
130mm

With Diamond



PS-1099
130mm

With Diamond

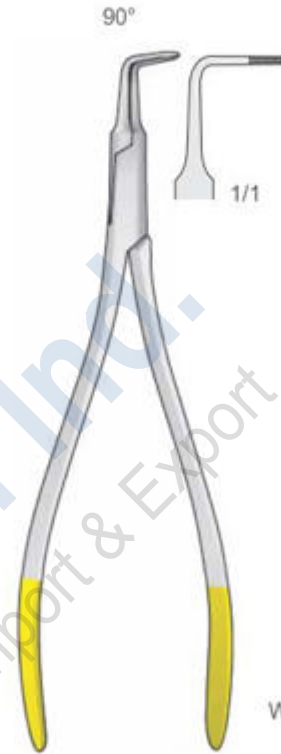

PS-1100
125mm

With Diamond



PS-1101
130mm



PS-1102
130mm



PS-1103
125mm

EXTRACTING FORCEPS (American Pattern)



- Щипцы экстракционные (американская форма)
- Dавiers - forme américaine
- Fórceps de extracción - forma americana
- Щипці екстракційні (американська форма)
- Pinzere per estrazione - forma americana
- استخراج المنطق (التمط الأمريكي)

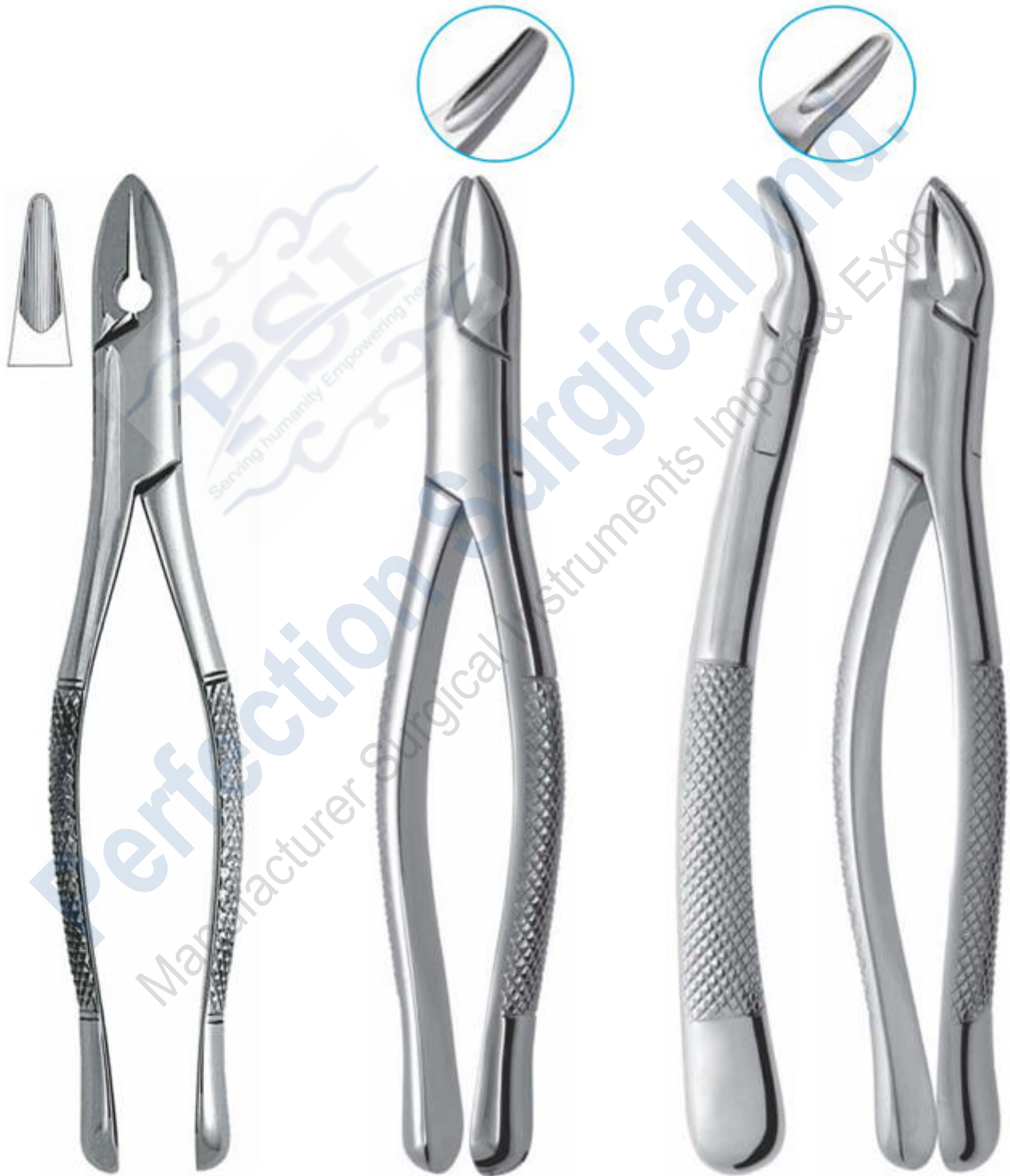

PS-1104
1STD
Winter
upper centrals and canines

PS-1105
Fig. 1
upper incisors
and roots

PS-1106
Cryer
Fig. 150

EXTRACTING FORCEPS (American Pattern)

- Щипцы экстракционные (американская форма)
- Щипці екстракційні (американська форма)
- Daviers - forme américaine
- Pinzeper per estrazione - forma americana
- Fórceps de extracción - forma americana
- استخراج المنكط (النمط الأمريكي)



PS-1108
Fig. 62
incisors, premolars,
deciduous teeth



PS-1109
10S
upper roots



PS-1110
17
lower molars



PS-1111
Harris
Fig. 18R



PS-1112
Harris
Fig. 18L



PS-1107
Fig. 150A
Cryer
upper incisors, premolars, roots

EXTRACTING FORCEPS (American Pattern)

- Щипцы экстракционные (американская форма)
- Dáviers - forme américaine
- Fórceps de extracción - forma americana
- Щипці екстракційні (американська форма)
- Pinzere per estrazione - forma americana
- استخراج المثلط (التمط الأمريكي)

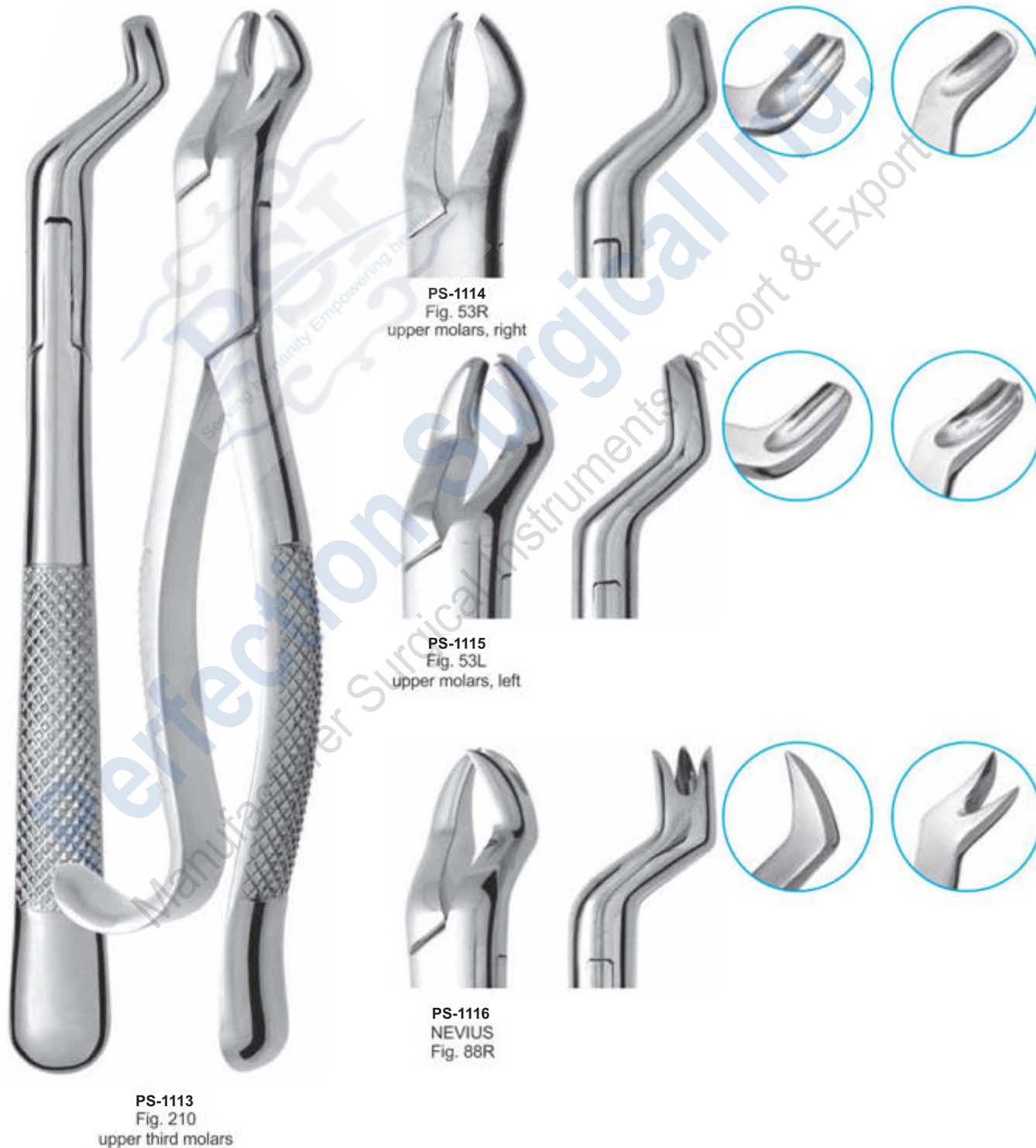

EXTRACTING FORCEPS (American Pattern)

- Щипцы экстракционные (американская форма)
- Щипці екстракційні (американська форма)
- Daviers - forme américaine
- Pinzeper per estrazione - forma americana
- Fórceps de extracción - forma americana
- استخراج المنطق (النمط الأمريكي)



PS-1117
Fig. 24
upper molars



PS-1118
210S
upper third molars



PS-1119
210H
upper third molars



PS-1120
286
Upper Roots,
Premolars, Incisors



PS-1121
99C
Kells
upper incisors,
canines, premolars



PS-1122
222
lower third molars



PS-1123
286
Lower Molar

EXTRACTING FORCEPS (American Pattern)



- Щипцы экстракционные (американская форма)
- Dавiers - forme americane
- Fórceps de extracción - forma americana
- Щипці екстракційні (американська форма)
- Pinzere per estrazione - forma americana
- استخراج المثلث (النمط الأمريكي)



PS-1124
Nevius
Fig. 88L
upper molars, left



PS-1125
Fig. 65
upper incisors
and roots



PS-1126
Parmly Fig. 32A
upper premolars
and roots



PS-1127
Parmly Fig. 32
upper premolars
and molars

EXTRACTING FORCEPS (American Pattern)

- Щипцы экстракционные (американская форма)
- Щипці екстракційні (американська форма)
- Daviers - forme américaine
- Pinzeper per estrazione - forma americana
- Fórceps de extracción - forma americana
- استخراج المنطق (النمط الأمريكي)

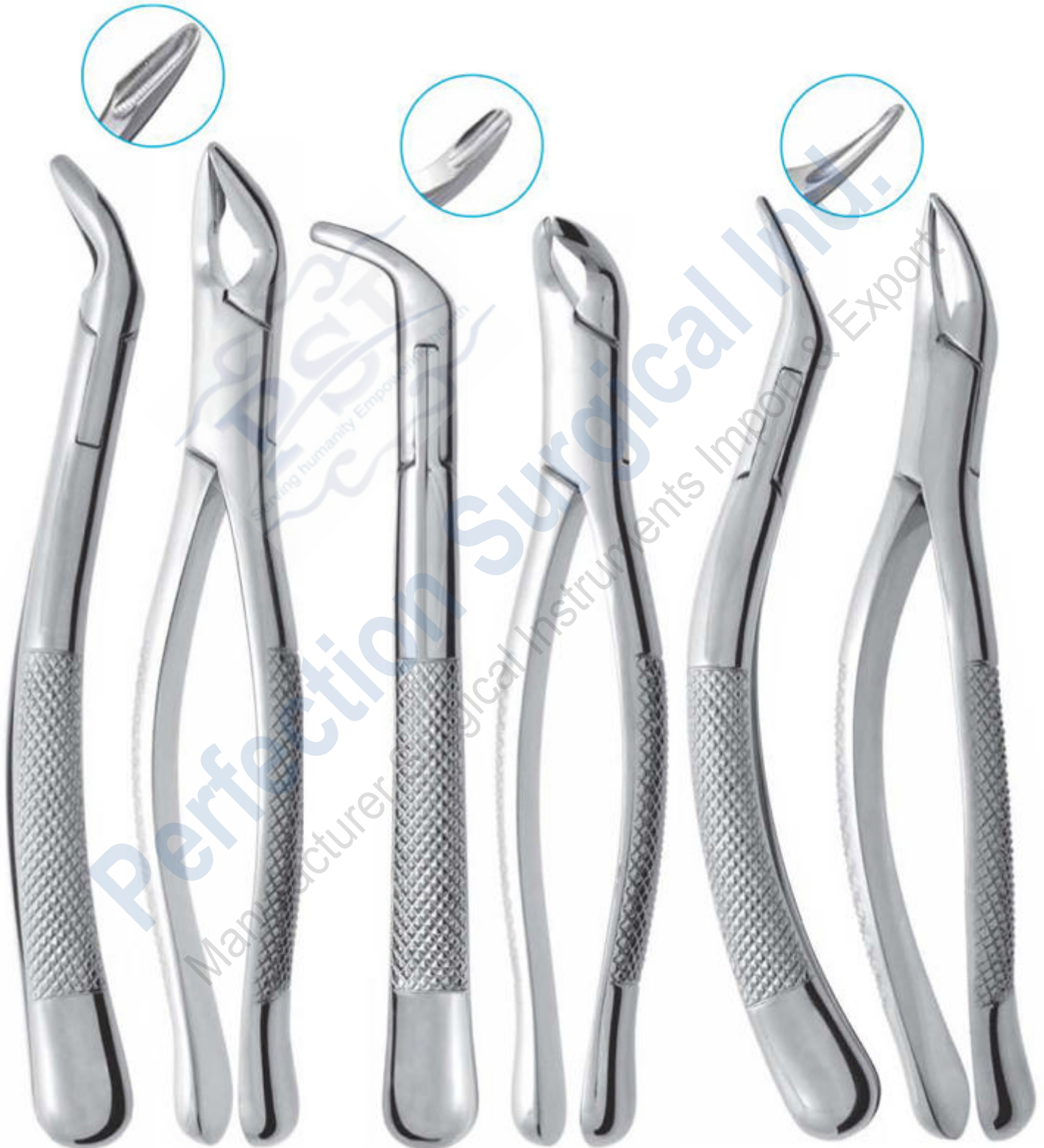

PS-1128
COHEN
universal

PS-1129
Fig. 203
lower incisors
and roots

PS-1130
Tomes Fig. 69
upper and lower
roots

EXTRACTING FORCEPS (American Pattern)

- Щипцы экстракционные (американская форма)
- Щипці екстракційні (американська форма)
- Dавiеrѕ - fоrme аmеricаne
- Pinzеper per еstrаzіone - fоrma аmericаnа
- Fоrсеps de еxtrассіоn - fоrma аmericаnа
- سٹخراج المنكط (النمط الأمريكي)



PS-1131
Fig. 23
lower molars

PS-1132
Fig. 16
lower molars

PS-1133
Physic Fig. 5
lower third molars

PS-1134
Harris Fig. 15
lower molars

PS-1135
Fig. 103

EXTRACTING FORCEPS (American Pattern)

- Щипцы экстракционные (американская форма)
- Щипці екстракційні (американська форма)
- Daviers - forme américaine
- Pinzeper per estrazione - forma americana
- Fórceps de extracción - forma americana
- استخراج المنكط (النمط الأمريكي)



PS-1136
Hull
Fig. 101
Deciduous teeth

PS-1137
Cryer
Fig. 150S
upper teeth,
for children

PS-1138
Fig. 150 AS

EXTRACTING FORCEPS (American Pattern)



- Щипцы экстракционные (американская форма)
- Daviers - forme américaine
- Fórceps de extracción - forma americana
- Щипці екстракційні (американська форма)
- Pinzere per estrazione - forma americana
- استخراج المثلث (النمط الأمريكي)



PS-1139
Cryer
Fig. 151
lower teeth,
for children

PS-1140
Fig. 151 S
lower incisors,
premolars, roots

PS-1141
Fig. 151 AS

EXTRACTING FORCEPS (American Pattern)

- Щипцы экстракционные (американская форма)
- Daviers - forme américaine
- Férceps de extracción - forma americana
- Щипці екстракційні (американська форма)
- Pinzoper per estrazione - forma americana
- استخراج المنطق (النمط الأمريكي)



PS-1142
16S
lower molars for children



PS-1143
17S
lower molars



PS-1144
23 S
Lower molars

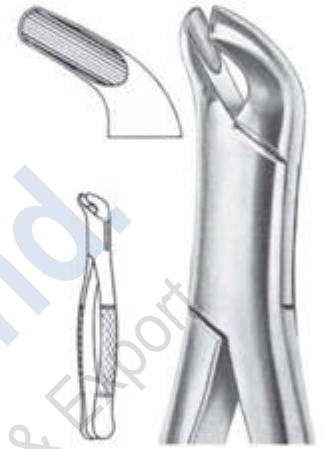

PS-1145
27
lower molars



PS-1146
18LS
upper molars left



PS-1147
18RS
upper molars right



PS-1148
85 Tomas
lower canines, premolars and molars



PS-1149
85A Tomas
lower canines, premolars and molars



PS-1150
69S
upper and lower roots



PS-1151
99A Kells
upper incisors, canines, premolars



PS-1152
217
lower molars

EXTRACTING FORCEPS (American Pattern)



- Щипцы экстракционные (американская форма)
- Daviers - forme américaine
- Fórceps de extracción - forma americana
- Щипці екстракційні (американська форма)
- Pinzere per estrazione - forma americana
- استخراج المثلث (النمط الأمريكي)



PS-1153
#10 SK
Upper Molars Sup



PS-1154
#17 SK Universal
Lower Molars



PS-1155
#23 SK Universal
Upper Molars



PS-1156
#69 SK Tomas
upper and lower roots



PS-1157
#99 SK
upper incisors,
canines, premolars



PS-1158
#150 SK
upper incisors,
premolars, roots



PS-1159
#151 SK
lower incisors,
premolars, roots



PS-1160
#222 SK
lower third molars

EXTRACTING FORCEPS (American Pattern)

- Щипцы экстракционные (американская форма)
- Щипці екстракційні (американська форма)
- Daviers - forme américaine
- Pinzeper per estrazione - forma americana
- Férceps de extracción - forma americana
- مستخراج الملقط (النمط الأمريكي)



PS-1161
Fig. 1
Upper Anterior

PS-1162
Lower Molar
Fig. 23 Cow Horn



PS-1163
Fig. 74
Lower Anterior



PS-1164
Fig. 88L
Upper Molar Left



PS-1165
Fig. 88R
Upper Molar Right



PS-1166
Fig. 74
Lower Anterior



PS-1167
Fig. 106
Lower Incisors



PS-1168
Fig. 174
Extra Narrow
Lower Anterior
Apical Retention
Forceps



PS-1169
Fig. 859
Lower Molars
Roots



EXTRACTING FORCEPS (American Pattern)



- Щипцы экстракционные (американская форма)
- Щипці екстракційні (американська форма)
- Pinzere per estrazione - forma americana
- Stئراج الملفظ (النمط الأمريكي)
- Daviers - forme américaine
- Fôrceps de extracci3n - forma americana

Carbide Diamond Coated Point



PS-1171
151 T.C.
Carbide Serrated Beak
Lower Incisors, Cuspids,
Bicuspids & Roots, Universal



PS-1172
1STD T.C.
Carbide Serrated Beak
Upper Incisors, Cuspids,



PS-1173
17 T.C.
Carbide Serrated Beak
1st & 2nd Lower Molars,
Universal



PS-1174
53L T.C.
Carbide Serrated Beak
1st & 2nd Upper Molars,
Left



PS-1175
53R T.C.
Carbide Serrated Beak
1st & 2nd Upper Molars,
Right



PS-1176
65 T.C.
Carbide Serrated Beak
Upper Incisors, Roots &
Fragments



PS-1170
150 T.C.
Carbide Serrated Beak
Upper Incisors, Cuspids,
Bicuspids & Roots,
Universal



PS-1177
69 T.C.
Carbide Serrated Beak
Upper & Lower Fragments
And Roots



PS-1178
150S T.C. Podo forcep
Carbide Serrated Beak
Podo, Upper Primary Teeth
and Roots, Universal



PS-1179
151S T.C. Podo forcep
Carbide Serrated Beak
Podo, Lower Primary Teeth
and Roots, Universal

BONE ROUNGER

- Костные кусачки
- Hohlmeißelzangen
- Pincès-gouges
- Кусачки для кісток
- Pinzas-gubias
- روتجورس العظام



PS-1180
Blumenthal
15cm



PS-1181
Blumenthal
15cm



PS-1182
Blumenthal
15cm



PS-1183
Friedman
14cm



PS-1184
Friedman
14.5cm



PS-1185
Micro-Friedman
14cm



PS-1186
Micro-Friedman
15cm



PS-1187
Micro-Friedman
16cm



PS-1188
Kleinert-Kutz
18.5cm



PS-1189
Beyer
18.5cm



PS-1190
Mead 1A
18.5cm



PS-1191
Luer
18.5cm

EXTRACTING FORCEPS (English Pattern)

- Щипцы экстракционные (английская форма)
- Шипці екстракційні (англійська форма)
- Daviers (Forme Anglaise)
- Forceps de Extracción (Forme Inglesa)
- Zahnzangen (Englische Form)
- استخراج الملقط (تمط اللغة الإنجليزية)

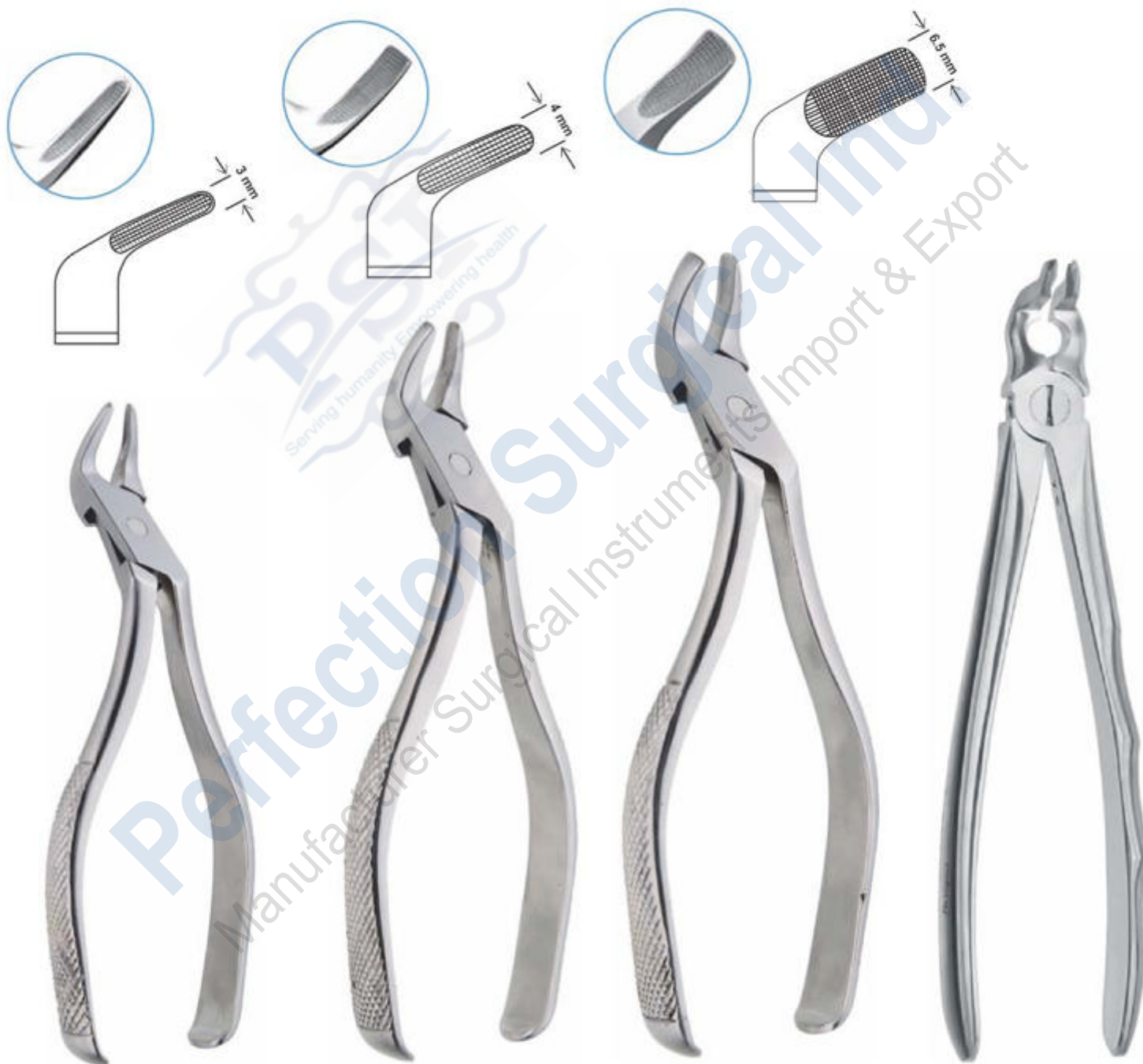

PS-1192
Meissner
Extracting Forceps

PS-1193
Meissner
Extracting Forceps

PS-1194
Meissner
Extracting Forceps

PS-1195
Comellas Forceps
Anatomical Handle

DENTAL SYRINGES

- Шприцы стоматологические карпульные
- Шприці стоматологічні карпульні
- Seringues à usage dentaire
- Jeringas dentales
- Dentalspritzen
- المحاقن الأسنان



PS-1196 1.8ml
PS-1197 2.2ml



PS-1198 1.8ml
PS-1199 2.2ml



PS-1200 1.8ml
PS-1201 2.2ml



PS-1202 1.8ml
PS-1203 2.2ml



PS-1204 1.8ml
PS-1205 2.2ml



Hi1206 1.8ml
PS-1207 2.2ml



PS-1208
1001
Intraligamental
Anesthesia
Syringe in
Black Colour



PS-1209 1.8ml
PS-1210 2.2ml
Angled



PS-1211
Aluminium - Dark 1.8 ml

- | | | | |
|---|---|--|---------------------------------------|
| | | | |
| PS-1212
Aluminium -
Silver 1.8 ml | PS-1213
Aluminium -
Orange 1.8 ml | PS-1214
Aluminium -
Green 1.8 ml | PS-1215
Aluminium -
Blue 1.8 ml |



Type C
PS-1216 1,8ml
PS-1217 2,2ml



Type C
PS-1218 1,8ml
PS-1219 2,2ml



2-Ring
PS-1220 1,8ml
PS-1221 2,2ml



Aspirating Syringe
PS-1222 1.8mm
PS-1223 2.2mm



Cartridge Syringe
PS-1224 1.8mm
PS-1225 2.2mm



Cartridge Syringe
PS-1226 1.8mm
PS-1227 2.2mm



Cartridge Syringe
PS-1228 1.8mm
PS-1229 2.2mm

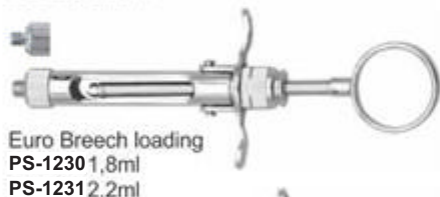

Euro Breech loading
PS-1230 1,8ml
PS-1231 2,2ml

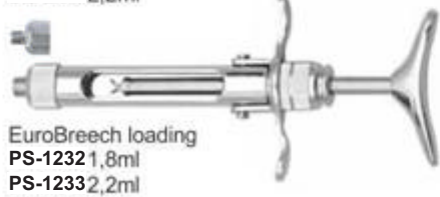

EuroBreech loading
PS-1232 1,8ml
PS-1233 2,2ml



Manual Aspirating Syringe
PS-1234 1,8ml
PS-1235 2,2ml

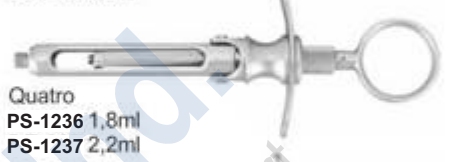

Quatro
PS-1236 1,8ml
PS-1237 2,2ml

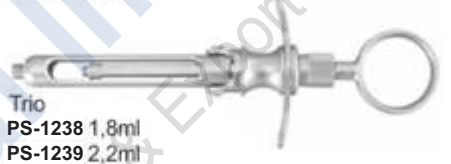

Trio
PS-1238 1,8ml
PS-1239 2,2ml



Swedish Type
PS-1240 1,8ml
PS-1241 2,2ml



Ject Ultima
PS-1242 1,8ml
PS-1243 2,2ml
Injects 0,05 ml with every click Supplied with
angled and straight tubes



Ject angled
PS-1244 1,8ml
PS-1245 2,2ml

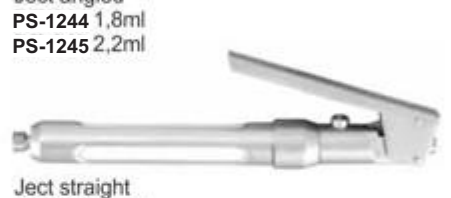

Ject straight
PS-1246 1,8ml
PS-1247 2,2ml



Disc System
PS-1248 1,8ml
PS-1249 2,2ml



Disc System
PS-1250 1,8ml

EXTRACTING FORCEPS SET



Извлечение щипцов
Ensemble de pinces d'extraction
• Zange sammeln

• Витягуючий комплект щипців
• Extracción del conjunto de fórceps
• استخراج ملقط مجموعة



PS-1251
Extracting Forceps
Set of 10 Pieces
Extracting Forceps Fig. 2
Extracting Forceps Fig. 7
Extracting Forceps Fig. 13
Extracting Forceps Fig. 17
Extracting Forceps Fig. 18
Extracting Forceps Fig. 22
Extracting Forceps Fig. 33
Extracting Forceps Fig. 51A
Extracting Forceps Fig. 67A
Extracting Forceps Fig. 79

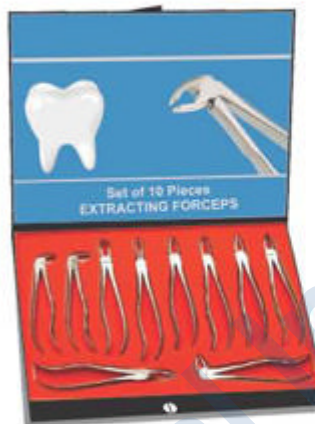

PS-1252
Extracting Forceps
Set of 10 Pieces
Extracting Forceps Fig. 2
Extracting Forceps Fig. 7
Extracting Forceps Fig. 13
Extracting Forceps Fig. 17
Extracting Forceps Fig. 18
Extracting Forceps Fig. 22
Extracting Forceps Fig. 33
Extracting Forceps Fig. 51A
Extracting Forceps Fig. 67A
Extracting Forceps Fig. 79



PS-1253
Extracting Forceps
Set of 13 Pieces
Extracting Forceps Fig. 2
Extracting Forceps Fig. 7
Extracting Forceps Fig. 13
Extracting Forceps Fig. 17
Extracting Forceps Fig. 18
Extracting Forceps Fig. 22
Extracting Forceps Fig. 33
Extracting Forceps Fig. 51A
Extracting Forceps Fig. 67A
Extracting Forceps Fig. 79
Extracting Forceps Fig. 86C
Extracting Forceps Fig. 89
Extracting Forceps Fig. 90



PS-1254
Extracting Forceps Children Pattern
Set of 10 Pieces
Extracting Forceps Fig. 13S
Extracting Forceps Fig. 22S
Extracting Forceps Fig. 30S
Extracting Forceps Fig. 33S
Extracting Forceps Fig. 37
Extracting Forceps Fig. 38
Extracting Forceps Fig. 39
Extracting Forceps Fig. 39L
Extracting Forceps Fig. 39R
Extracting Forceps Fig. 51S



PS-1255
Extracting Forceps English adult Adult
Set of 10 Pcs



PS-1256
Extracting Forceps American Adult
Set of 10 Pcs



PS-1257
Extracting Forceps American Adult
Set of 8 Pcs



PS-1258
Extracting Forceps Pedro
Set of 7 Pcs

ROOT ELEVATOR

FUNCTION OF ROOT ELEVATORS IN SURGERY

To Loosen Tooth or Root From Bony Socket Prior to Placement of The Extraction Forceps.

HANDLES FOR ROOT ELEVATORS POINTS A, B, C, D, E, F, G, H

Thumb Handle

A



Shortblast Handle

B



Half Gold Handle

C



Round With Edge Handle

D



Thom with Flat Handle

E



Finger Thom Handle

F



Anatomical Handle

G



Eye Style Handle

H



ROOT ELEVATOR

- Элеватор корневой экстракционный
- Elévateurs à racines
- Wurzelheber
- Elevator corneveiy ekstraktsionniy
- Elevadores para raices
- المعصاعد الجذر

Function of Root Elevators:

To loosen tooth or root from bony socket prior to placement of the extraction forceps.

Apexo Root Elevators



Luxator Root Elevators

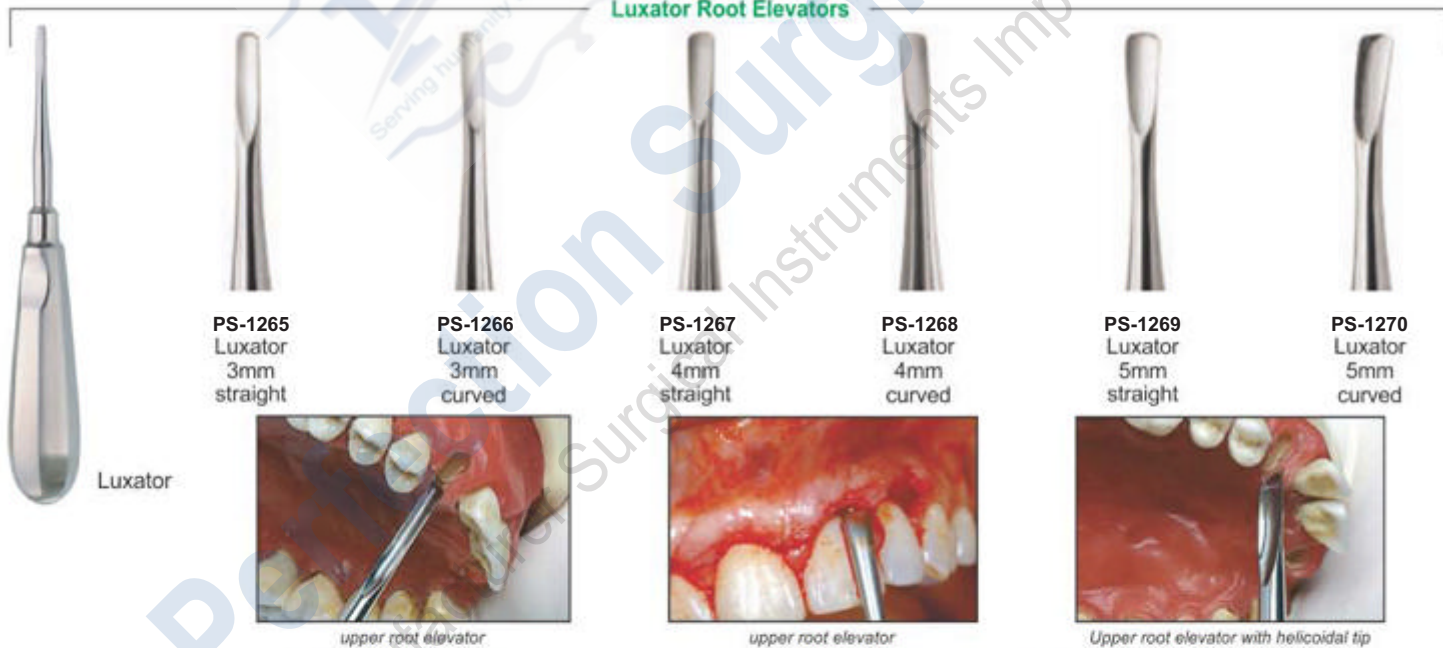

Bein Root Elevators

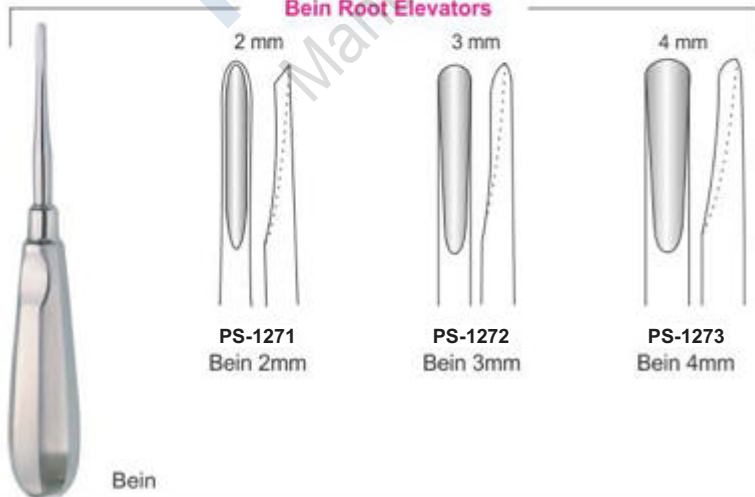

Seldin Root Elevators

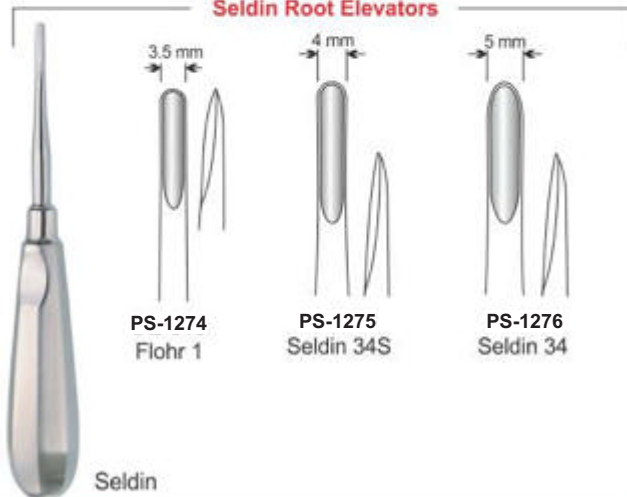

ROOT ELEVATOR

- Элеватор корневой экстракционный
- Elévateurs à racines
- Wurzelheber
- Слеватор корневий екстракційний
- Elevadores para raices
- المصاعد الجذر

FUNCTION: To loosen tooth or root from bony socket prior to placement of the extraction forceps.

Laxutor Root Elevators

Long Type



Laxutor Root Elevator



PS-1277
Laxutor
1.5mm
Str.



PS-1278
Laxutor
2mm
Str.



PS-1279
Laxutor
3mm
Str.



PS-1280
Laxutor
5mm
Str.



PS-1281
Laxutor
3mm
Cvd.



PS-1282
Laxutor
5mm
Cvd.



PS-1283
Laxutor
3mm
Upper Angle



PS-1284
Laxutor
3mm
Double Angle



PS-1285
Laxutor
3mm
Str.



PS-1286
Laxutor
5mm
Str.

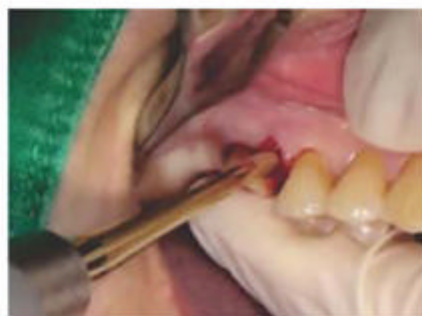

ROOT ELEVATOR

- Элеватор корневой экстракционный
- Elévateurs à racines
- Wurzelheber
- Слеватор корневий экстракційний
- Elevadores para raices
- المصاعد الجذر

Laxutor Root Elevators



lower roots elevator



Upper root elevator with helicoidal tip

Luxator Roots Elevator



PS-1296
Luxator
Straight

PS-1297
Luxator
Curved

Function of Root Elevators:

To loosen tooth or root from bony socket prior to placement of the extraction forceps.

Apical Root Elevators

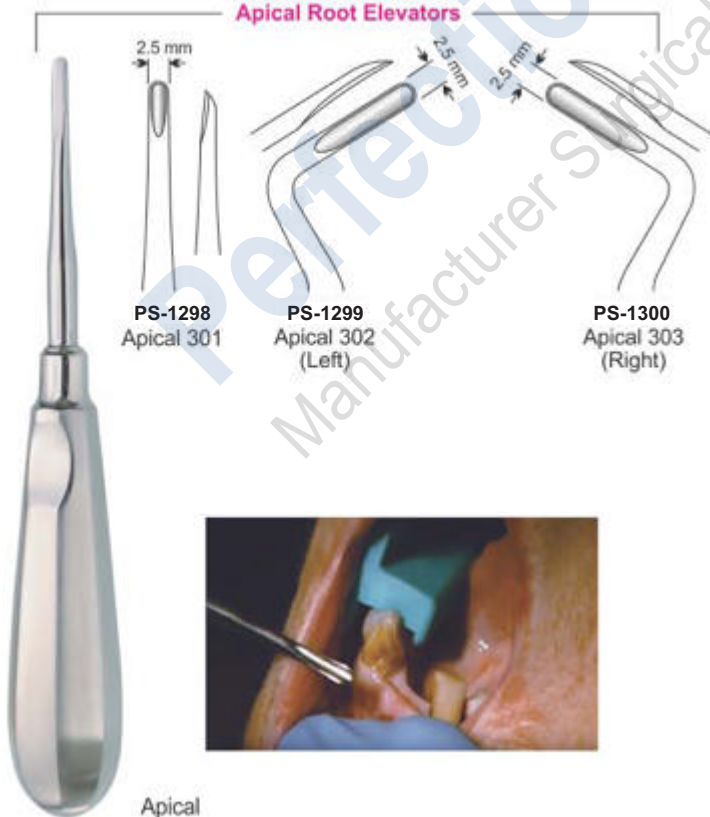

Apical

Apical Root Elevators

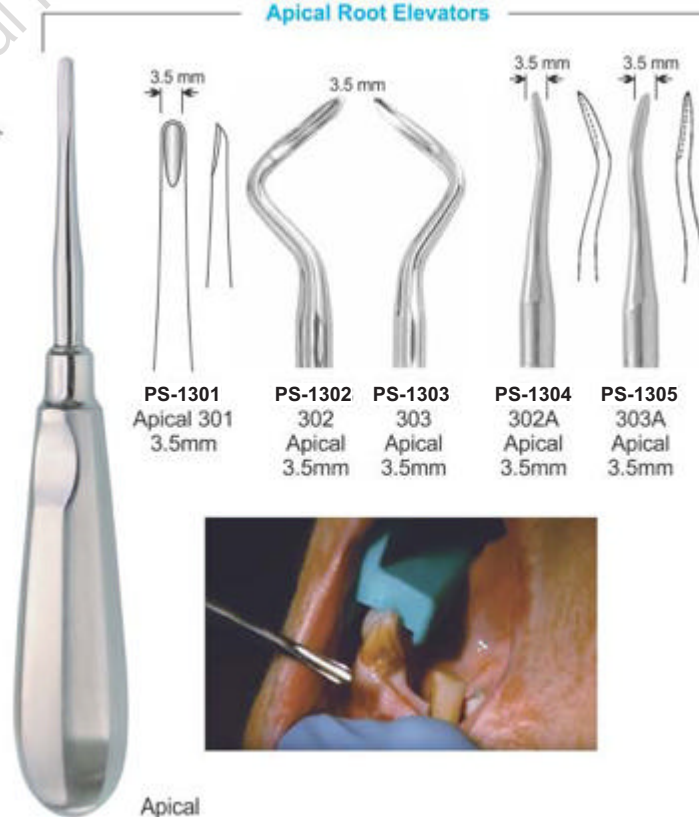

Apical



ROOT ELEVATOR

- Элеватор корневой экстракционный
- Elévateurs à racines
- Wurzelheber
- Слеватор корневий экстракційний
- Elevadores para raices
- المصاعد الجذر

FUNCTION: To Loosen Tooth or Root From Bony Socket Prior to Placement of The Extraction Forceps.

Cryer Root Elevators

PS-1306 Cryer Fig. 25

PS-1307 Cryer Fig. 26

PS-1308 Cryer 27 (Left)

PS-1309 Cryer 28 (Right)

PS-1310 Cryer Fig. 31

PS-1311 Cryer Fig. 32

PS-1312 Cryer Fig. 44

PS-1313 Cryer Fig. 45

Cryer Root Elevator

Cryer root or fragment elevator

Seldin root or fragment elevator

Seldin Root Elevators

PS-1314 Seldin 4L (Left)

PS-1315 Seldin 4R (Right)

PS-1316 Seldin 1L (Left)

PS-1317 Seldin 1R (Right)

PS-1318 Seldin (Left)

PS-1319 Seldin (Right)

Seldin

Cryer root or fragment elevator

Seldin root or fragment elevator

ROOT ELEVATOR

- Элеватор корневой экстракционный
 - Elévateurs à racines
 - Wurzelheber
- Слеватор корневий экстракційний
 - Elevadores para raices
 - المصاعد الجذر

FUNCTION: To Loosen Tooth or Root From Bony Socket Prior to Placement of The Extraction Forceps.

Apical Root Elevators

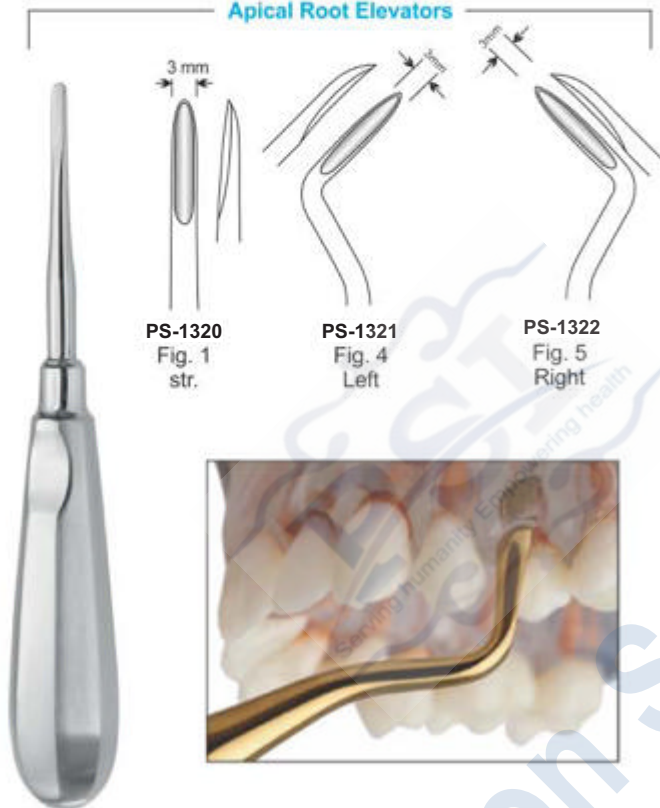

Apical Root Elevators

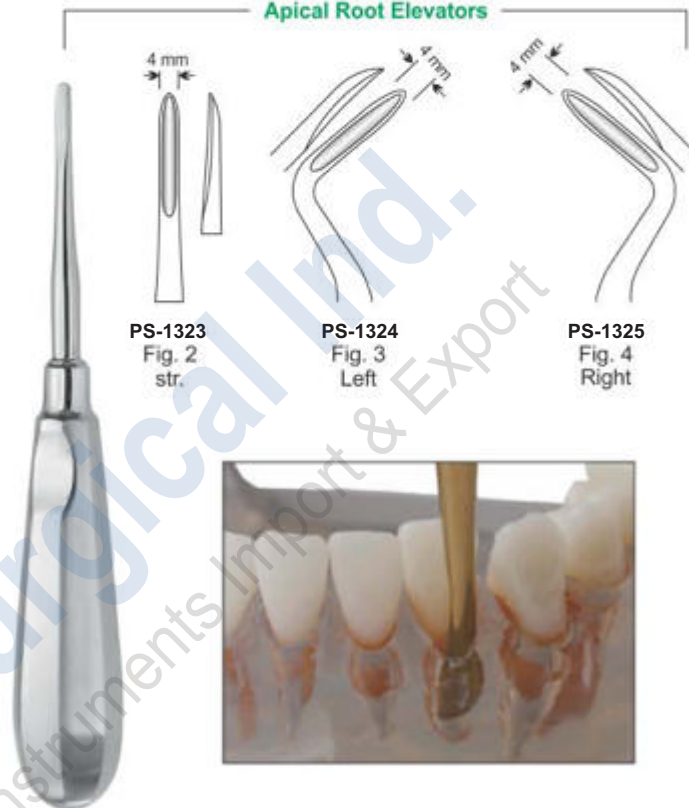

Flohr Root Elevators



Heidbrink Root Elevators

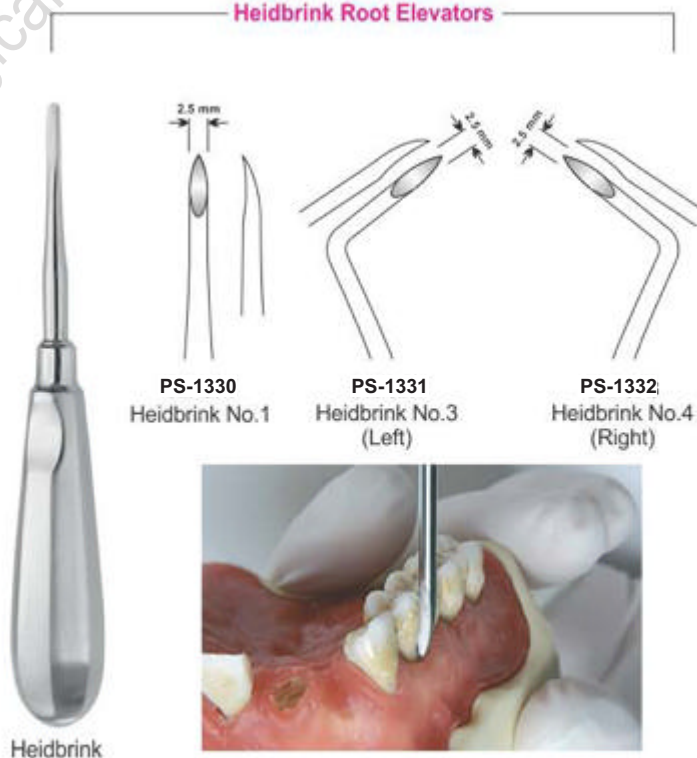

ROOT ELEVATOR

- Элеватор корневой экстракционный
- Elévateurs à racines
- Wurzelheber
- Слеватор корневий экстракційний
- Elevadores para raices
- المصاعد الجذر

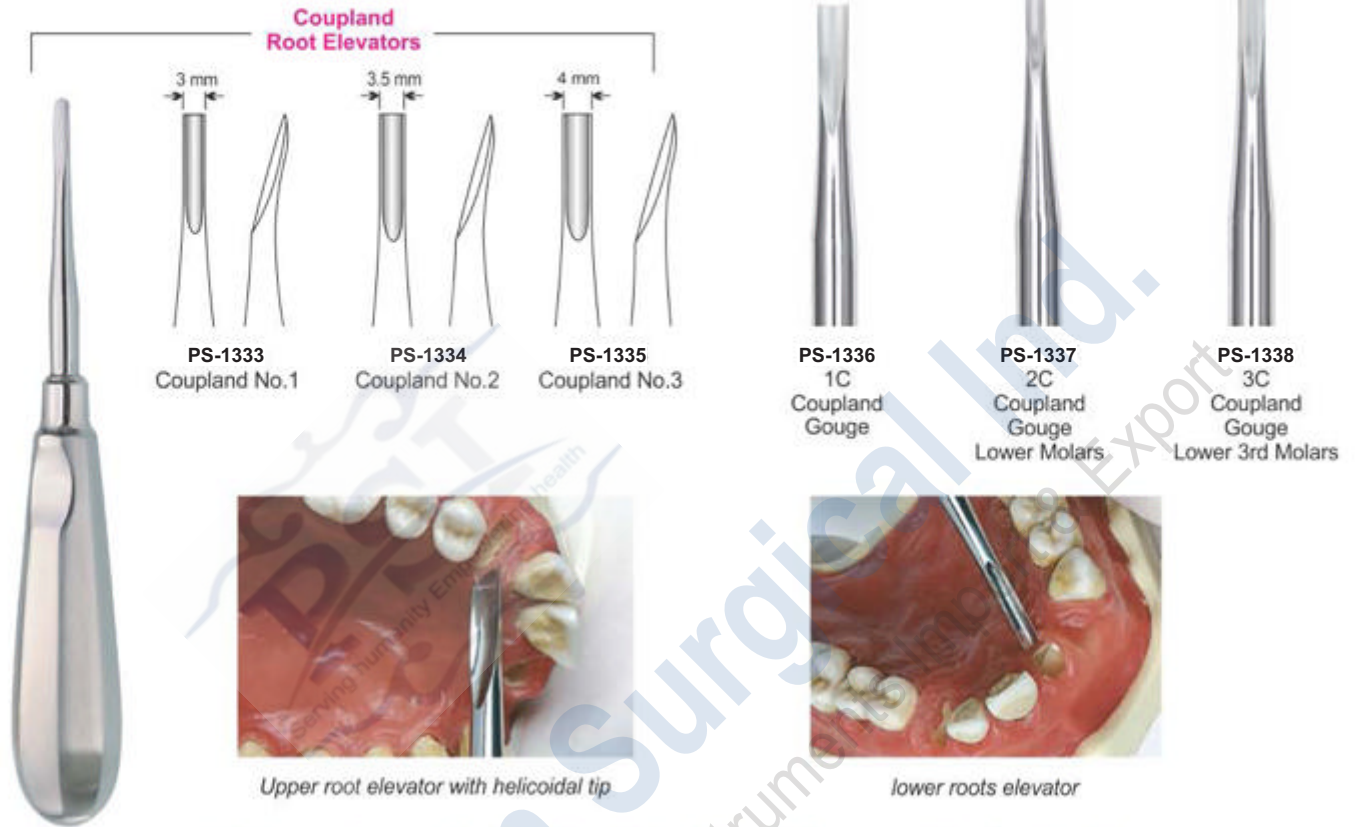

FUNCTION: To Loosen Tooth or Root From Bony Socket Prior to Placement of The Extraction Forceps.

ENGLISH PATTERNS



universal mini-elevator for fragments



ROOT ELEVATOR



- Элеватор корневой экстракционный
- Elévateurs à racines
- Wurzelheber
- Слеватор корневий екстракційний
- Elevadores para raices
- المصاعد الجذر

Lindo Levian Root Elevators

Function of Root Elevators:
To loosen tooth or root from bony socket prior to placement of the extraction forceps.



ROOT ELEVATOR

- Элеватор корневой экстракционный
- Elévateurs à racines
- Wurzelheber
- Слеватор корневий екстракційний
- Elevadores para raices
- المصاعد الجذر

Friedmann Roots Elevator



Hi1361
Friedmann 4F
Str.

PS-1362
Friedmann 5F
Left

Hi1363
Friedmann 6F
Right

Luxating Elevator With Periotome Tip



PS-1364
3mm Luxating
Elevator / Periotome

PS-1365
4mm Luxating
Elevator / Periotome

PS-1366
5mm Luxating
Elevator / Periotome

Wisdom Roots Elevator



PS-1367
Wisdom
for 18 and 38

PS-1368
Wisdom
for 28 and 48

Function of Root Elevators: To loosen tooth or root from bony socket prior to placement of the extraction forceps.

Bayonet Roots Elevator Set



PS-1369
Left

PS-1370
Right

PS-1371
bayonet

PS-1372
Curved

PS-1373
Straight

ROOT ELEVATOR

- Элеватор корневой экстракционный
- Elévateurs à racines
- Wurzelheber
- Слеватор корневий екстракційний
- Elevadores para raices
- المصاعد الجذر

Miller Root Elevators

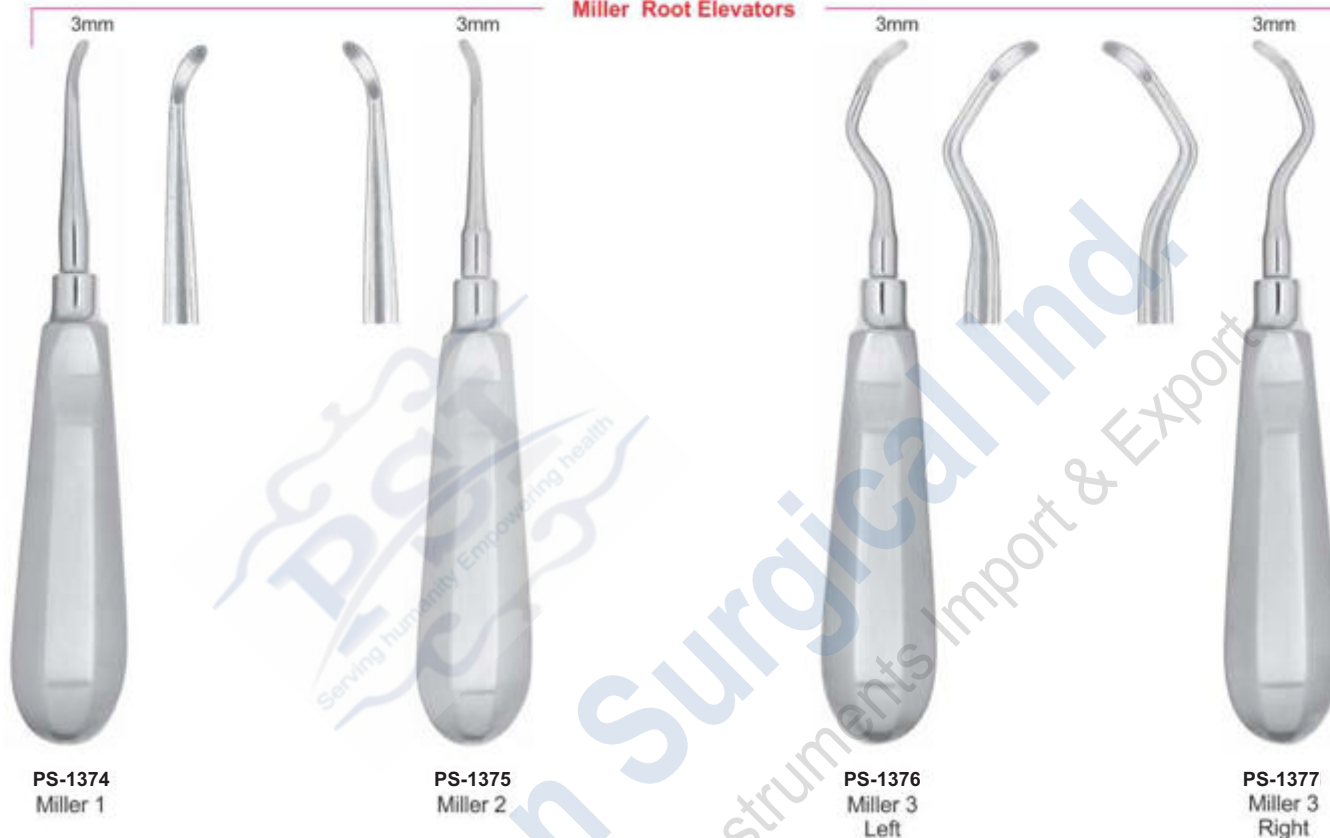

Function of Root Elevators: To loosen tooth or root from bony socket prior to placement of the extraction forceps.

Claw-Lift Roots Elevator

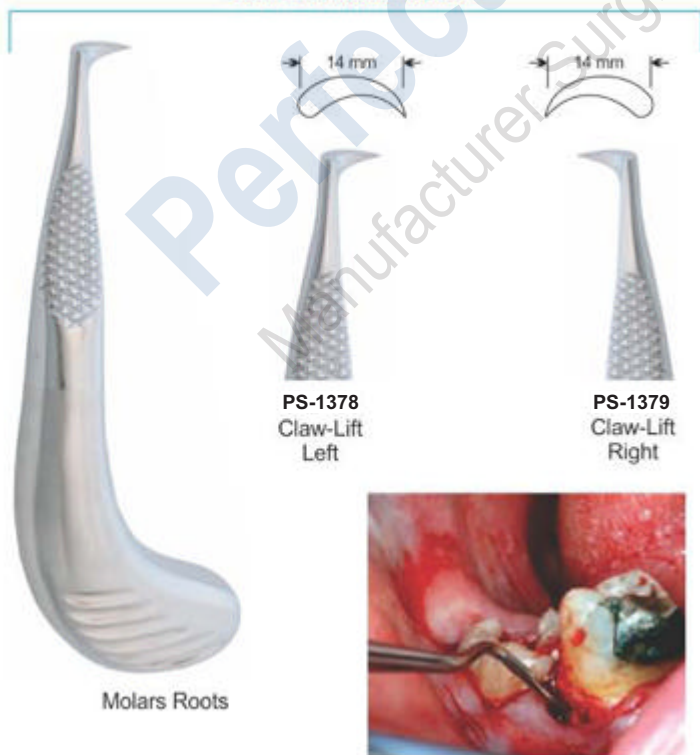

Schlemmer Roots Elevator



ROOT ELEVATOR

- Элеватор корневой экстракционный
- Elévateurs à racines
- Wurzelheber
- Слеватор корневий екстракційний
- Elevadores para raices
- المصاعد الجذر

FUNCTION: To Loosen Tooth or Root From Bony Socket Prior to Placement of The Extraction Forceps.

Laxutor Root Elevators Set of 9 Pcs



PS-1383
2mm Str.



PS-1384
3mm Str.



PS-1385
5mm Str.



PS-1386
3mm Cvd.



PS-1387
5mm Cvd.



PS-1388
3mm Angle



PS-1389
3mm Angle



PS-1390
3mm Str.



PS-1391
5mm Str.

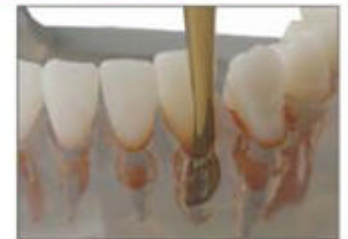

ROOT ELEVATOR

- Элеватор корневой экстракционный
- Elévateurs à racines
- Wurzelheber
- Слеватор корневий екстракційний
- Elevadores para raices
- المصاعد الجذر

Hylin Roots Elevator



Function of Root Elevators: To loosen tooth or root from bony socket prior to placement of the extraction forceps.

Kopp Roots Elevator

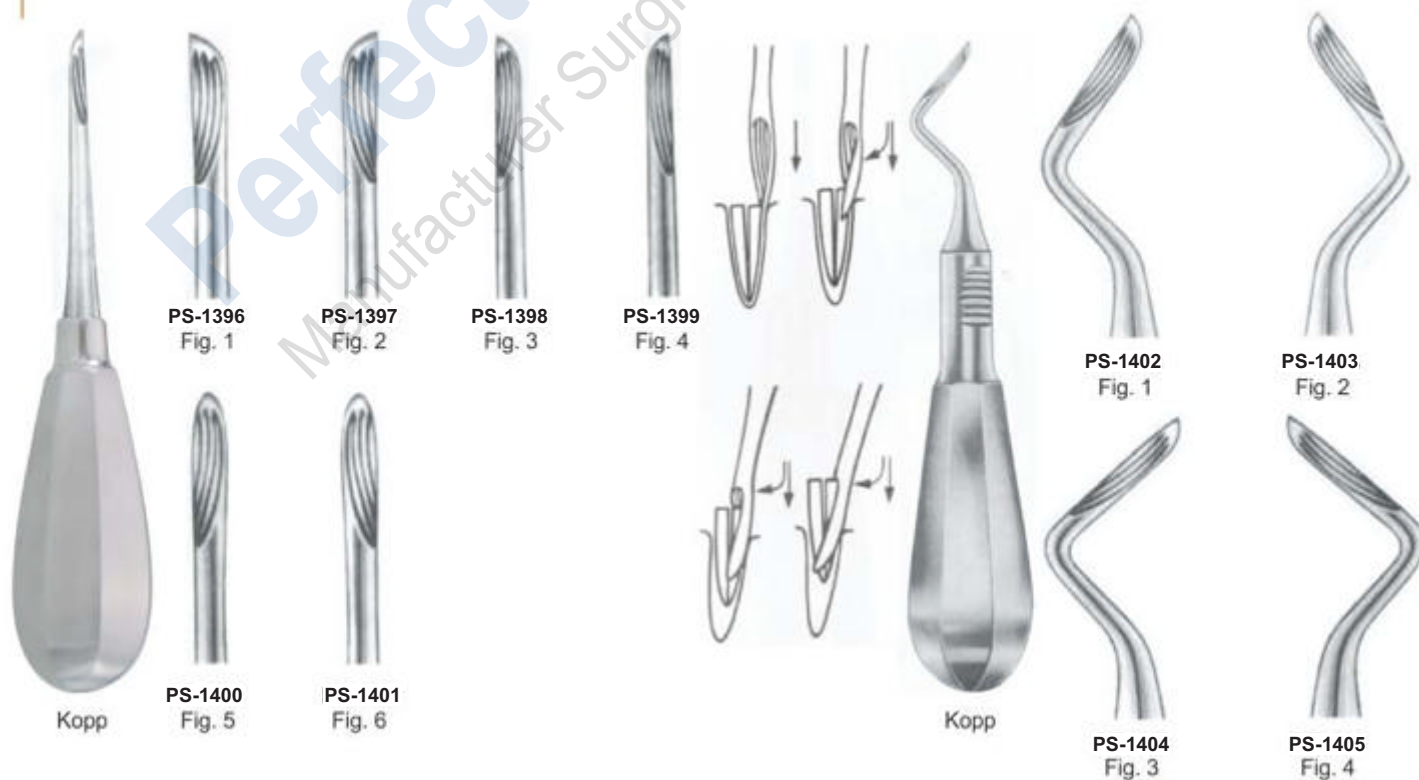

ROOT ELEVATOR

- Элеватор корневой экстракционный
- Elévateurs à racines
- Wurzelheber
- Слеватор корневий екстракційний
- Elevadores para raices
- المصاعد الجذر

Luxier Roots Elevator



PS-1406
Luxier
Cvd.

PS-1407
Luxier
Str.



Heber Roots Elevator



PS-1408
Heber
Bayonet

PS-1409
Heber
Bayonet



Bein Roots Elevator



PS-1410
Bein,
3mm

PS-1411
Bein,
4mm

Function of Root Elevators: To loosen tooth or root from bony socket prior to placement of the extraction forceps.

Bein Roots Elevator



ROOT ELEVATOR

- Элеватор корневой экстракционный
- Elévateurs à racines
- Wurzelheber
- Слеватор корневий экстракційний
- Elevadores para raices
- المصاعد الجذر

W. Barry Roots Elevator

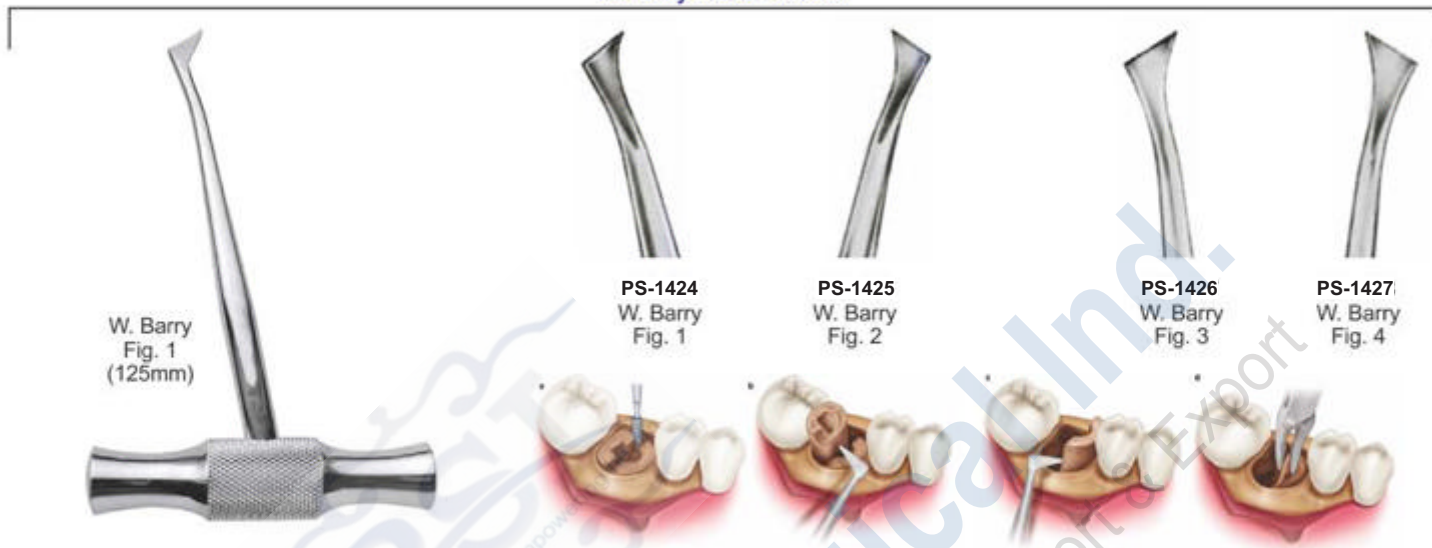

Function of Root Elevators: To loosen tooth or root from bony socket prior to placement of the extraction forceps.



ROOT ELEVATOR

- Элеватор корневой экстракционный
- Elévateurs à racines
- Wurzelheber
- Слеватор корневий екстракційний
- Elevadores para raices
- المصاعد الجذر



PS-1441
Fig. 1
Chompret



PS-1442
Fig. 2
Chompret



PS-1443
Fig. 3
Chompret



PS-1444
Fig. 4
Chompret



Lecluse elevator for lower third molar dislocation



Chompret syndesmotome, sickle pattern

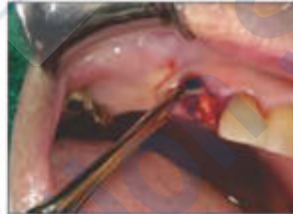

PS-1445



PS-1446



PS-1447



PS-1448



PS-1449



PS-1450



PS-1451

Root Pick Elevator With Gold Flexible Points

ROOT ELEVATOR

- Элеватор корневой экстракционный
- Elévateurs à racines
- Wurzelheber
- Слеватор корневий экстракційний
- Elevadores para raices
- المصاعد الجذر

Heidbrink Roots Elevator



PS-1452 Heidbrink Straight
 PS-1453 Heidbrink Left
 PS-1454 Heidbrink Right
 PS-1455 Heidbrink Straight
 PS-1456 Heidbrink Left
 PS-1457 Heidbrink Right

Syndesmotomes Roots Elevator



PS-1458| Syndesmotomes Straight
 PS-1459 Left
 PS-1460 Right

Periotome Roots Elevator



PS-1461 Periotome 2.1mm Straight
 PS-1462 Periotome 2.6mm Straight
 PS-1463 Periotome 2.1mm Angular
 PS-1464 Periotome 2mm Curved
 PS-1465 Periotome 2.0mm
 PS-1466 Periotome 2.5mm
 PS-1467 Periotome 3.0mm
 PS-1468 Periotome 4.0mm

Syndesmotomes

ROOT ELEVATOR

- Элеватор корневой экстракционный
- Слеватор кореневий екстракційний
- Elévateurs à racines
- Elevadores para raices
- Wurzelheber
- المصاعد الجذر

FUNCTION: To loosen small root fragments from bony socket

Heidbrink Roots Elevator

Warwick-James

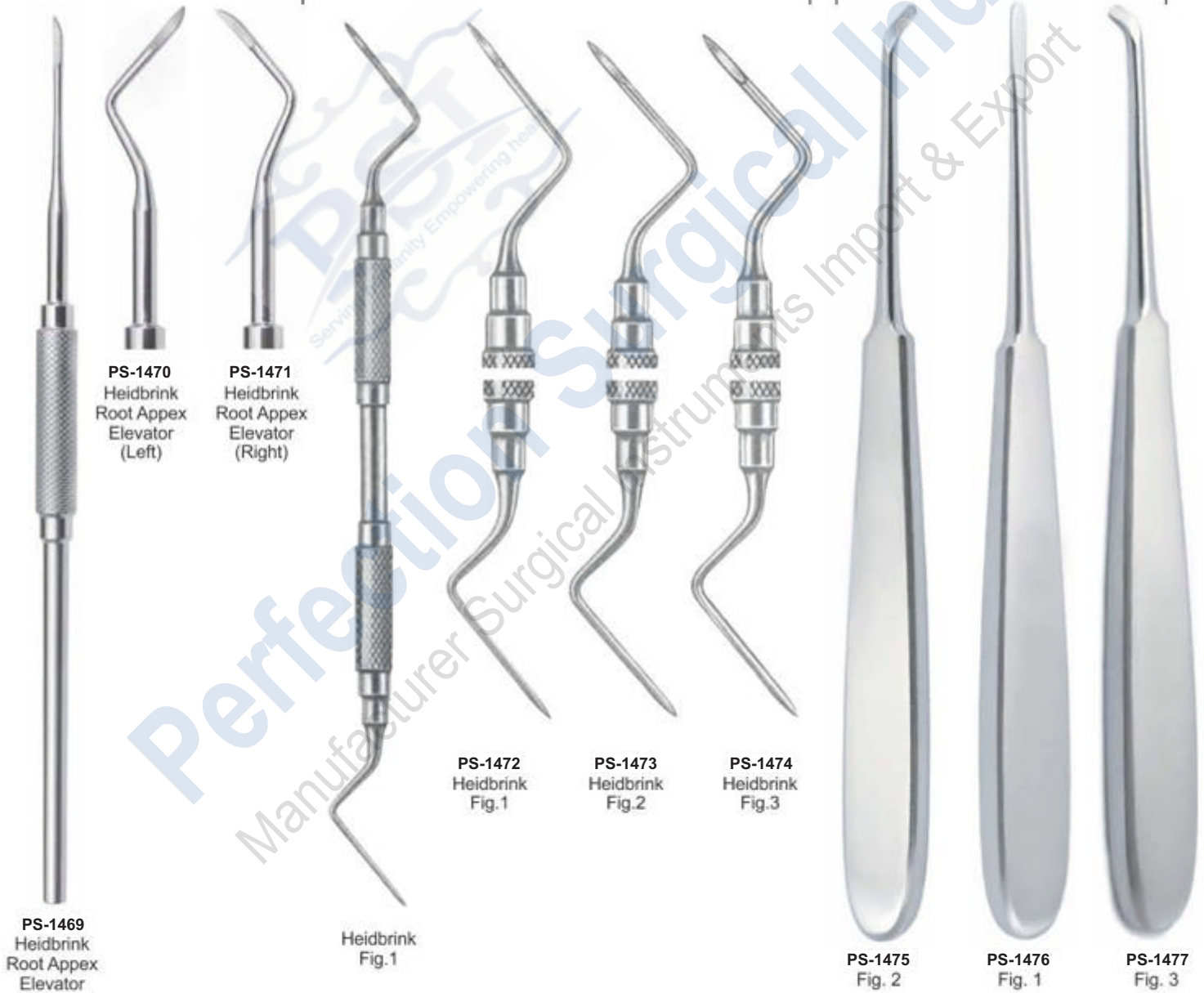

ROOT ELEVATOR

- Элеватор корневой экстракционный
- Elévateurs à racines
- Wurzelheber
- Слеватор корневий екстракційний
- Elevadores para raices
- المصاعد الجذر



PS-1478
1S
(Straight 1mm)



PS-1479
2S
(Straight 2mm)



PS-1480
3S
(Straight 3mm)



PS-1481
5S
(Straight 5mm)



PS-1482
3C
(Curved 3mm)



PS-1483
5C
(Curved 5mm)



PS-1484
3CA
(Curved Angle 3mm)



PS-1485
3IC
(Inverted Curved 3mm)



PS-1486
DE 3
(Dual Edge 3mm / 1.5mm)



PS-1487
DE 5
(Dual Edge 5mm / 3mm)

ROOT ELEVATOR

- Элеватор корневой экстракционный
- Elévateurs à racines
- Wurzelheber
- Слеватор корневий екстракційний
- Elevadores para raíces
- المصاعد الجذر

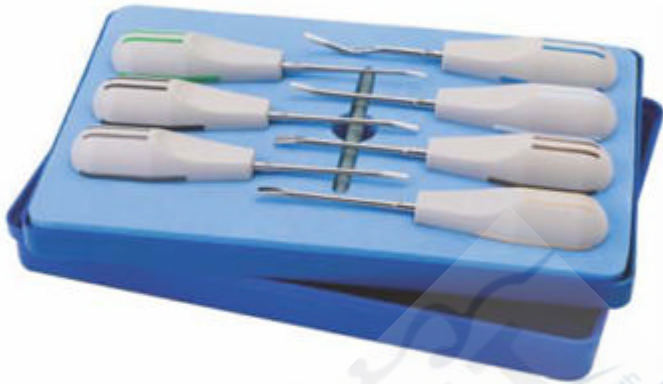

PS-1488
Luxators Set of 7 Pcs



PS-1489
Luxators Set of 7 Pcs



PS-1490
Luxators Set of 8 Pcs



PS-1491
Root Elevators Set of 10 Pcs



PS-1492
Elevators Set of 8 Pcs



PS-1493
Elevators Set of 8 Pcs

ROOT ELEVATOR

- Элеватор корневой экстракционный
 - Elévateurs à racines
 - Wurzelheber
- Elevator corneviu extracționii
 - Elevadores para raices
 - المعساعد الجذر

PDL ELEVATORS



Distal, 2.5mm
Micro Edge

Mesial, 2.5mm
Micro Edge

Distal, 4mm
Micro Edge

Mesial, 4mm
Micro Edge

2.5mm
Micro Edge, curved

2.5mm
Micro Edge, Straight

3.4mm
Straight

PS-1494
PDL Elevators
Set of 7 Pcs



Distal, 4mm
Micro Edge

Mesial, 4mm
Micro Edge

Distal, 2.5mm
Micro Edge

Mesial, 2.5mm
Micro Edge

2.5mm
Micro Edge, curved

2.5mm
Micro Edge, Straight

3.4mm
Straight

PS-1495
PDL Elevators
Set of 7 Pcs

ROOT ELEVATOR

- Элеватор корневой экстракционный
- Elévateurs à racines
- Wurzelheber
- Слеватор корневий екстракційний
- Elevadores para raices
- المصاعد الجذر

PDL ELEVATORS

Delicate Arrow tip



4,0mm straight
4,0mm curved

Luxivators straight
atraumatic luxation of the tooth



2,5mm straight
3,5mm straight
4,5mm straight

Luxivators curved
atraumatic luxation of the tooth



2,5mm curved
3,5mm curved
4,5mm curved



PS-1496
PDL Elevators
Set of 8 Pcs

Our Scalers

Compare our scalers and curettes with the best in the industry and you will immediately recognize we are equal in every way but one... price. Note the deep precision knurling for better tactile feel. The same high-grade stainless steel tips, the same light weight (under 18 grams) for less hand fatigue, the same professional craftsmanship, and surpassing the highest industry standards. of course, any manufacturer can make these claims, but we guarantee and certify ours.

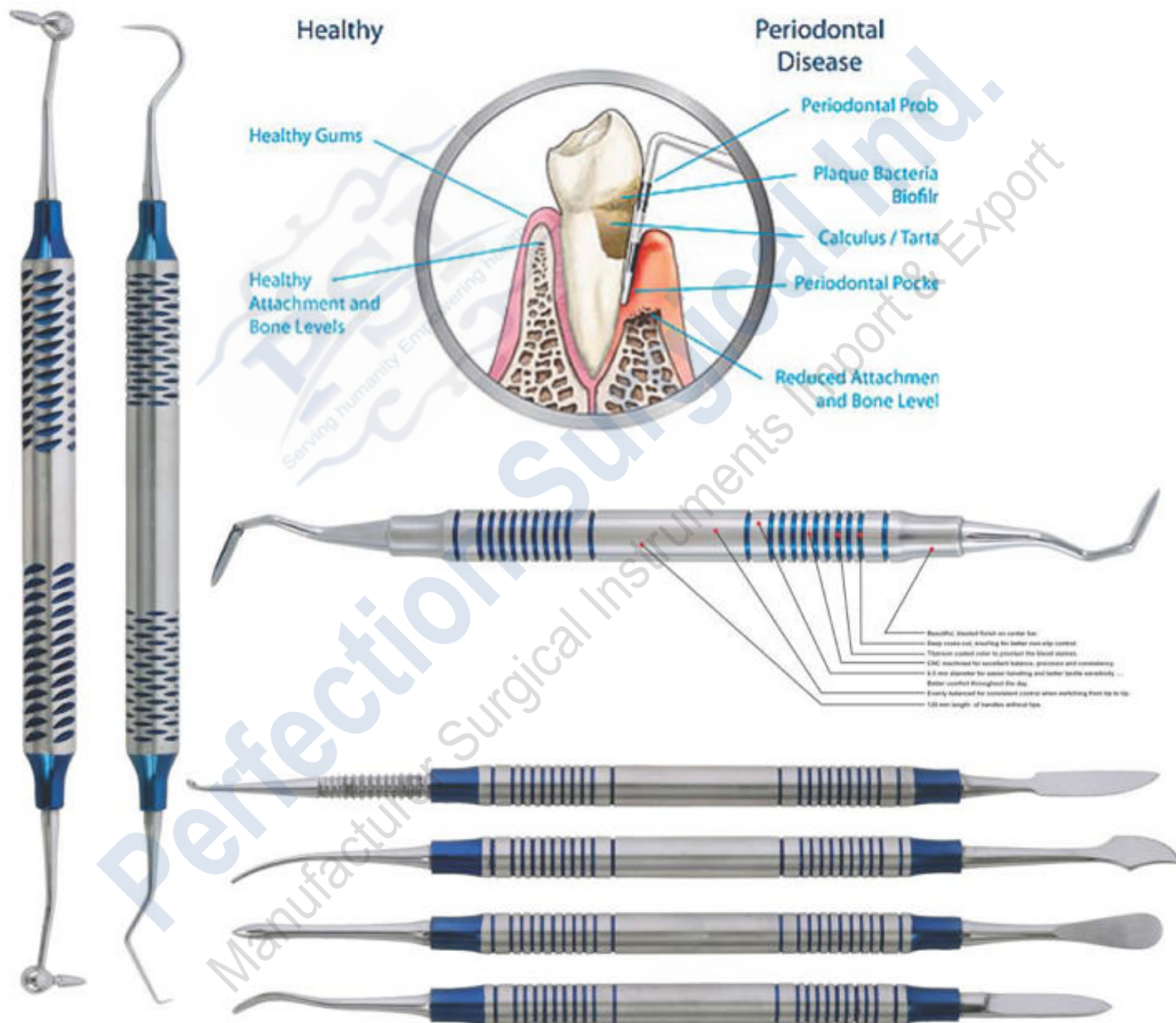

- High-polish mirror finish tips.
- Manufactured within the guidelines of the FDA quality assurance system for good manufacturing practices.
- Highest grade German stainless steel, razor sharp, durable tips. Rockwell hardened to 60 RHc.
- 27 of the most popular designs from gracesys to McCalls to columbias, and many european patterns.
- All instruments are guaranteed against defects in material and workmanship.

- All instruments bear the CE mark, emblematic of the european community's highest standards.
- Customer satisfaction guarantee, too!
- Less than 20 grams ... Lightweight for less hand fatigue.
- Manufactured to the most exacting standards so the 50th instrument you buy is exactly like your first.
- You decide ... Why pay more for the same high-quality instruments?

VALUED BUYERS

Compare our scalers and curettes with the best in the industry and you will immediately recognize we are equal in every way but one... price. Note the deep precision knurling for better tactile feel. The same high-grade stainless steel tips, the same light weight (under 20 grams) for less hand fatigue, the same professional craftsmanship, and surpassing the highest industry standards. Of course, any manufacturer can make these claims, but we guarantee and certify ours. We regularly manufacturing below articles in showing handles & pattern A to L for better grip & perfection. We are also fully equipped & capable to develop these instruments as per your own specific requirements & demands in materials, sizes, shapes and patterns.



A-Hollow Handle Ø 10 mm



B-Hollow Handle Ø 10 mm



C-Hollow Handle Ø 10 mm



D-Hollow Handle Ø 10 mm



E-Hollow Handle Ø 10 mm



F-Hollow Handle Ø 10 mm



G-Hollow Handle Ø 10 mm



H-Hollow Handle Ø 6.4 mm



I-Hollow Handle Ø 8 mm



J-Hollow Handle Ø 10 mm



K-Soild Handle Ø 6 mm



L-Soild Handle Ø 6 mm

MOUTH MIRRORS



- зеркала
- Espejos de la boca
- Mundspiegel
- дзеркала
- Miroirs à la bouche
- مرايا الفم

Plain



PS-1497 Fig. 3 Ø20mm
 PS-1498 Fig. 4 Ø22mm
 PS-1499 Fig. 5 Ø24mm
 PS-1500 Fig. 6 Ø26mm



Cone-Socket Plain



PS-1511 Fig. 3 Ø20mm
 PS-1512 Fig. 4 Ø22mm
 PS-1513 Fig. 5 Ø24mm

Magnifying



PS-1501 Fig. 3 Ø20 mm
 PS-1502 Fig. 4 Ø22 mm
 PS-1503 Fig. 5 Ø24 mm



Cone-Socket Magnifying



PS-1514 Fig. 3 Ø20mm
 PS-1515 Fig. 4 Ø22mm
 PS-1516 Fig. 5 Ø24mm

Rhodium



PS-1504 Fig. 3 Ø20mm
 PS-1505 Fig. 4 Ø22mm
 PS-1506 Fig. 5 Ø24 mm



Cone-Socket Rhodium



PS-1517 Fig. 3 Ø20mm
 PS-1518 Fig. 4 Ø22mm
 PS-1519 Fig. 5 Ø24mm

Front Surface



PS-1507 Fig. 3 Ø20mm
 PS-1508 Fig. 4 Ø22mm
 PS-1509 Fig. 5 Ø24mm
 PS-1510 Fig. 6 Ø26mm



Cone-Socket Front Surface



PS-1520 Fig. 3 Ø20mm
 PS-1521 Fig. 4 Ø22mm
 PS-1522 Fig. 5 Ø24mm

HANDLES FOR MOUTH MIRRORS

- Ручки для зеркал
- Manches pour miroirs à bouche
- Mundspiegelgriffe
- Ручки для дзеркал
- Mangos para espejos de boca
- مقابض لمرآة الفم



PS-1523
Hollow Mirror
Handle Round
Ø 10 mm



PS-1524
Hollow Mirror
Hexagonal
Handle
Ø 8 mm



PS-1525
Hollow
Handle
Ø 8 mm



PS-1526
Hollow Mirror
Hexagonal
Handle
Ø 10 mm



PS-1527
Hollow Mirror
Handle
Ø 8 mm



PS-1528
Hollow Mirror
Handle
Ø 10 mm



PS-1529
Mirror Handle
Solid
Ø 6 mm



PS-1530
Mirror Handle
Solid
Ø 6 mm



PS-1531
Mirror Handle
Solid Octagonal
Ø 6 mm



PS-1532
Mirror Handle
Stem
with Rule
35mm



PS-1533
Mirror Handle
Solid
Stem with
Rule 35mm



PS-1534
Cone-Socket
Solid Octagonal
Ø 6 mm



PS-1535
Cone-socket
Solid
Ø 6 mm



PS-1536
Cone-socket
Hexagonal
Handle
Ø 6 mm

Cone-Socket Mirror Handle

EXPLORERS



- Зонды
- Зонди
- Sondes
- Sondas
- Zahnsonden
- المسكشكين

Examination kit Set of 3 Pieces



PS-1537 Probe
HIR-1538 Mirror
PS-1539 College Forcep 15cm



Examination Set of 4 Pieces



PS-1540 Exp,23/17-A
PS-1541 Excavators
PS-1542 Tweezers
PS-1543 Mouth Mirror

PS-1544

First Aid Examination Set of 3 Pieces



PS-1545

First Aid Examination Set of 3 Pieces



PS-1546

First Aid Examination Set of 3 Pieces



PS-1547

First Aid Examination Set of 3 Pieces



TWEEZERS

- Пинцеты
 - Pincettes - Brucelles
 - Zahnpinzetten
- Пінцети
 - Pinzas para algodón
 - ملاقط



PS-1548
Surgical
11.5cm



PS-1549
London College
15cm



PS-1550
Semken Taylor
Str.



PS-1550
Semken Taylor
Cvd.



PS-1551
Meriam
16cm



PS-1552
Dressing
14cm



PS-1553
Semken Taylor
1x2 Straight



PS-1554
Semken Taylor
1x2 Curved



PS-1555
Gilles
15cm 1x2



PS-1556
14cm 1x2



PS-1557
Perry
13cm



PS-1558
Atraumatic
15cm Cvd



PS-1559
Atraumatic
15cm Str.



PS-1560
College with Lock
15cm Cvd.



PS-1561
Gerald
17.5cm



PS-1562
with lock
15cm



PS-1563
Atraumatic
17.5cm

TWEEZERS



- Пинцеты
- Pincettes - Brucelles
- Zahnpinzetten

- Пинцети
- Pinzas para algodón
- ملائف



PS-1566
Adson-TC
12cm



PS-1567
Adson-TC
12cm 1x2



PS-1568
Adson-TC
15cm 1x2



PS-1569
Adson
12cm



PS-1570
Adson
12cm 1x2



PS-1571
Adson
15cm 1x2



PS-1572
Adson Brown
12cm



PS-1573
Crane Kaplan
15cm



PS-1574
Crane Kaplan
15cm



PS-1575
Crane Kaplan
15cm



PS-1576
Hemingway
15cm



PS-1577
Miller
15cm Str.



PS-1578
Miller
15cm Cvd.



PS-1579
Dressing
Tweezer
14.5cm



PS-1580
College
Curved
Tweezer
Tip 15cm



PS-1581
Maryam
Tweezers
15cm



PS-1582
College
Tweezer
15cm



PS-1583
Perry
Tweezer
12.5cm



PS-1584
Self-locking
Tweezer
15cm

EXPLORERS

- Зонды
- Sondes
- Zahnsonden
- Зонди
- Sondas
- المستكشفين

Single Ended Probe Solid Handle 4.5mm Length 150mm



Explorers-Single-End

Double-Ended Explorers

PS-1600
23
Shepherd's
Hook
Explorer

PS-1601
Explorer

PS-1602
TU 17/23
Wilkins/Tufts
Explorer

PS-1603
1

PS-1604
DG 16
Thick

PS-1605
DG 16/23

PS-1606
DG 16/17

PS-1607
1
Abou-Rass
Explorers

EXPLORERS



- Зонды
- Зонди
- Sondes
- Sondas
- Zahnsonden
- المستكشفين

Probes Double Ended 6mm, length 170mm

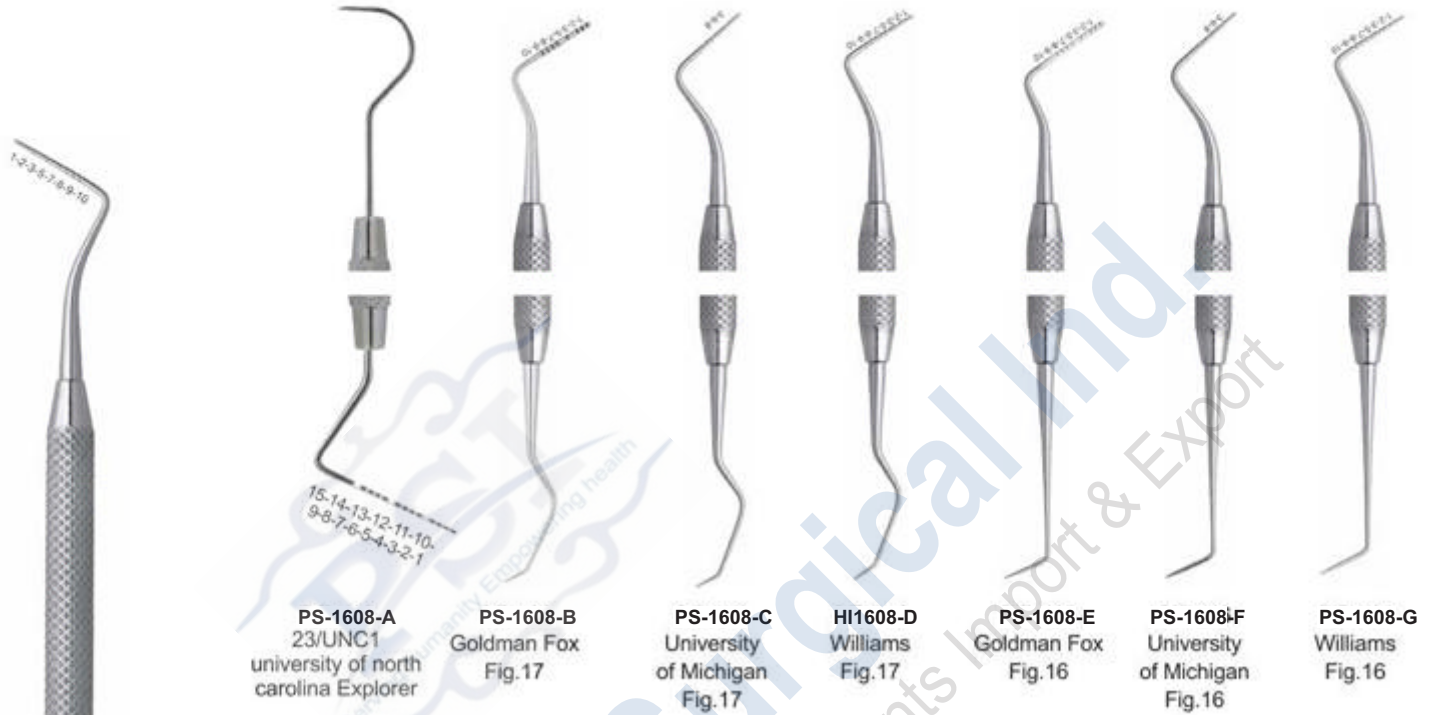

Pointed Probes Double Ended Handle 6mm, length 170mm

PS-1608
Williams

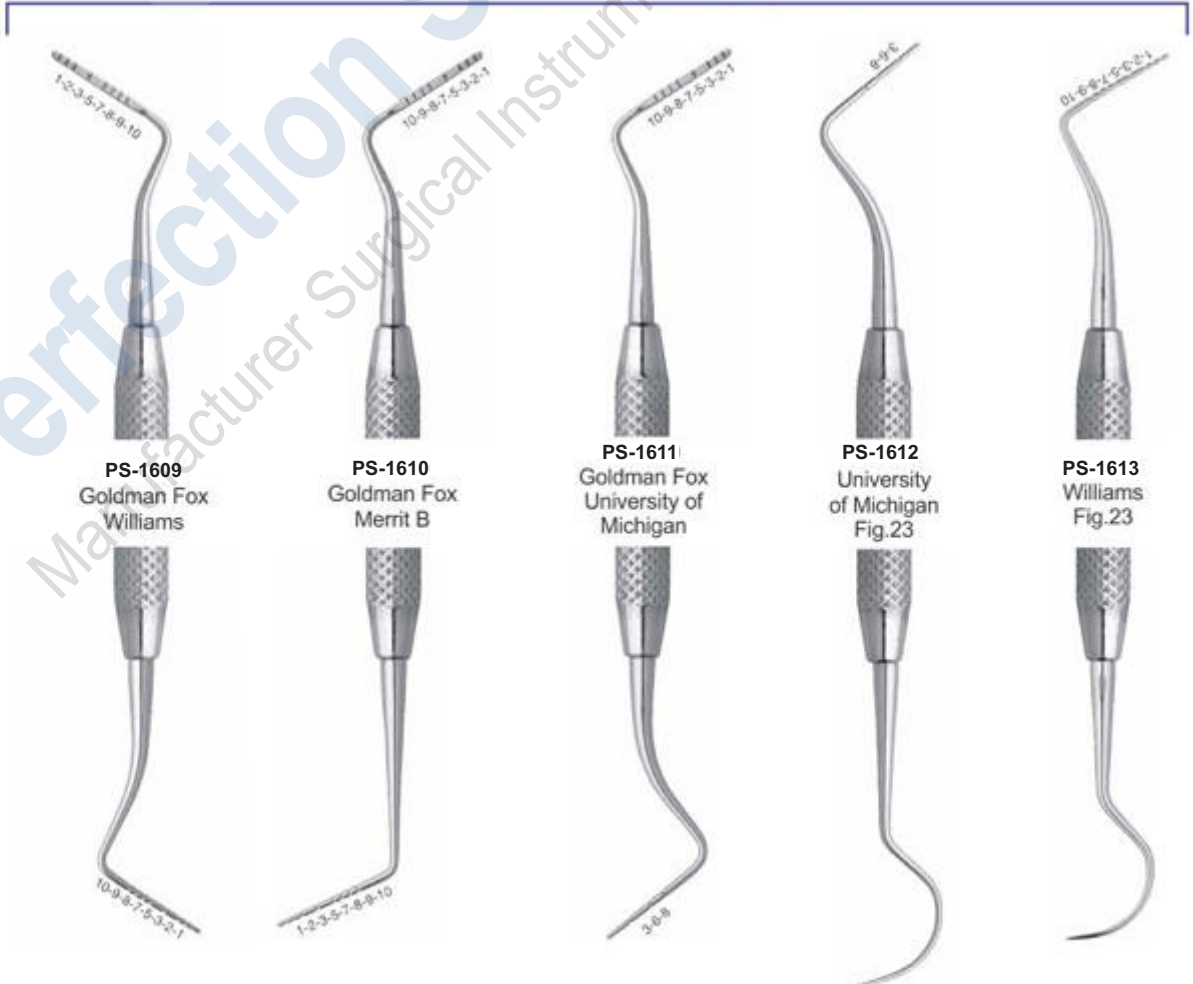

EXPLORERS

- Зонды
- Sondes
- Zahnsonden
- Зонди
- Sondas
- المستكشفين

EXPLORERS INSTRUMENTS SOLID HANDLE 6MM, LENGTH 170MM

PLUGGERS

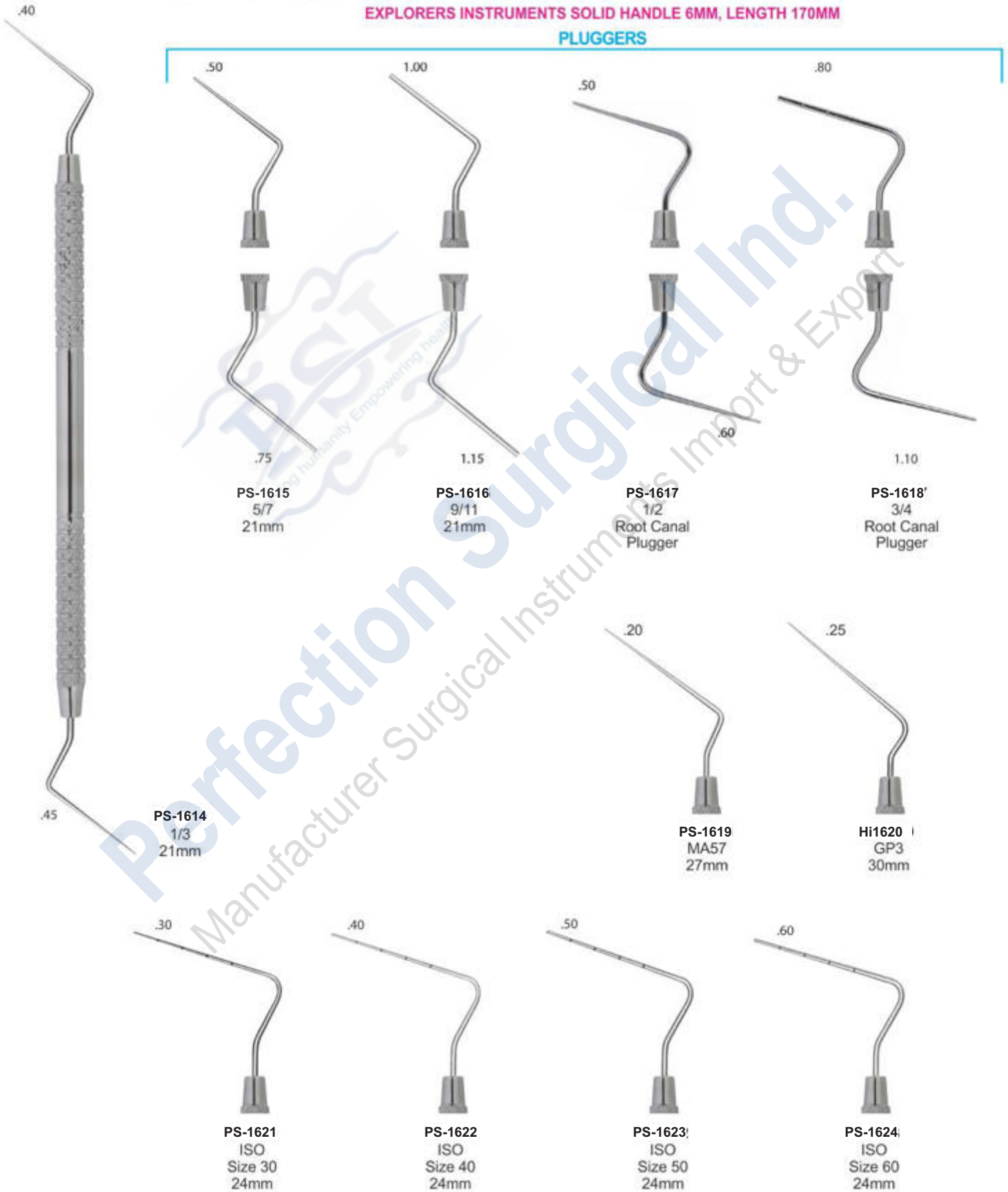

- .50
- 1.00
- .50
- .80
- .75
- 1.15
- .60
- 1.10
- PS-1615
5/7
21mm
- PS-1616
9/11
21mm
- PS-1617
1/2
Root Canal
Plugger
- PS-1618'
3/4
Root Canal
Plugger
- .45
- PS-1614
1/3
21mm
- .20
- .25
- PS-1619
MA57
27mm
- Hi1620 |
GP3
30mm
- .30
- .40
- .50
- .60
- PS-1621
ISO
Size 30
24mm
- PS-1622
ISO
Size 40
24mm
- PS-1623
ISO
Size 50
24mm
- PS-1624
ISO
Size 60
24mm

PERIODONTAL PROBES



- Зонды пародонтологические
 - Sondes paradontales
 - sonda parodontall
- зонди пародонтологічні
 - Sondas paradontales
 - المسابر اللثة

SPREADERS

HEAT CARRIERS

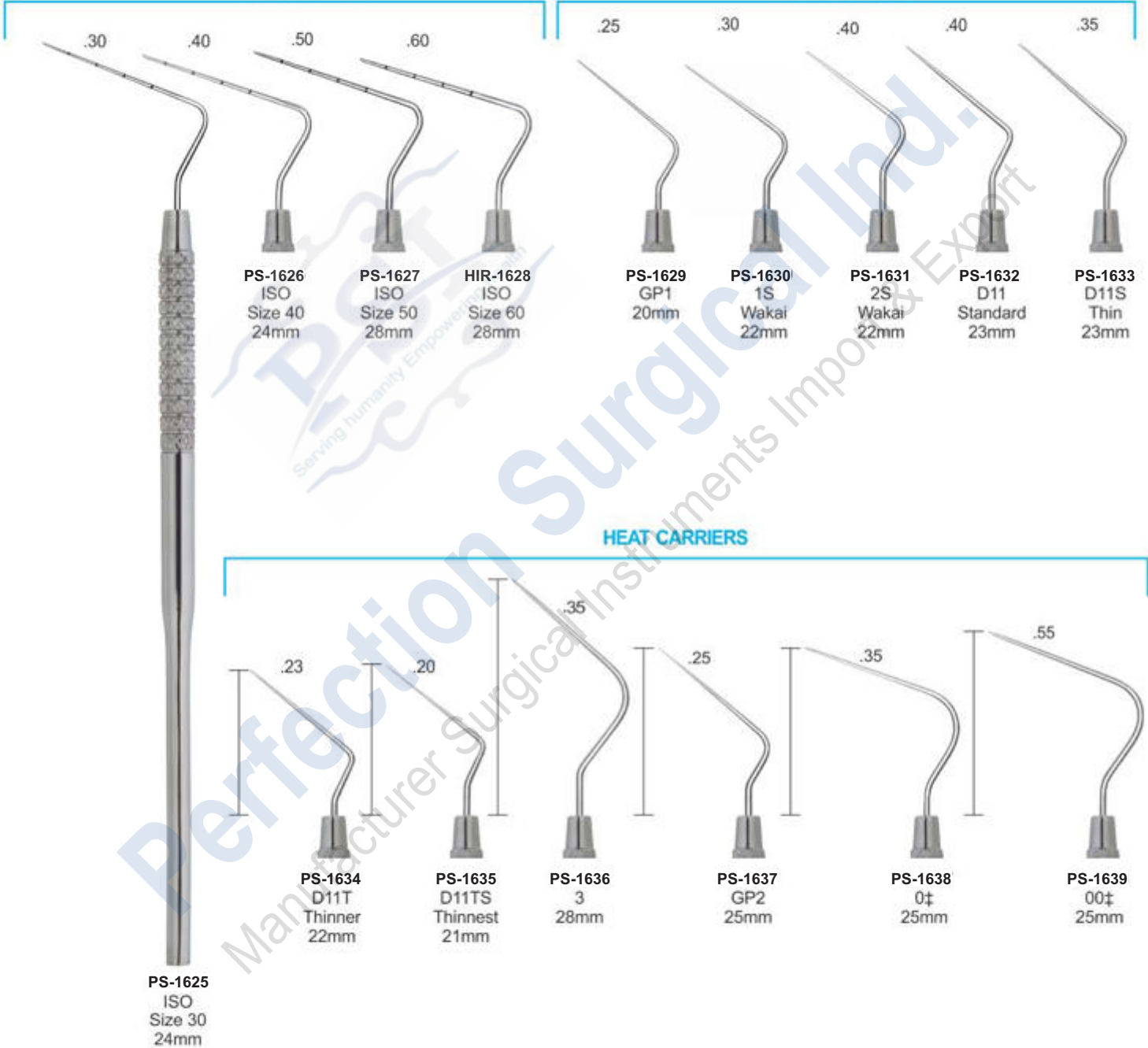

PERIODONTAL PROBES

- Зонды пародонтологические
 - Sondes parodontales
 - sonda parodontali
- зонди пародонтологічні
 - Sondas parodontales
 - المسابر اللثة

ENDODONTICS INSTRUMENTS

ANTERIOR



LUKS

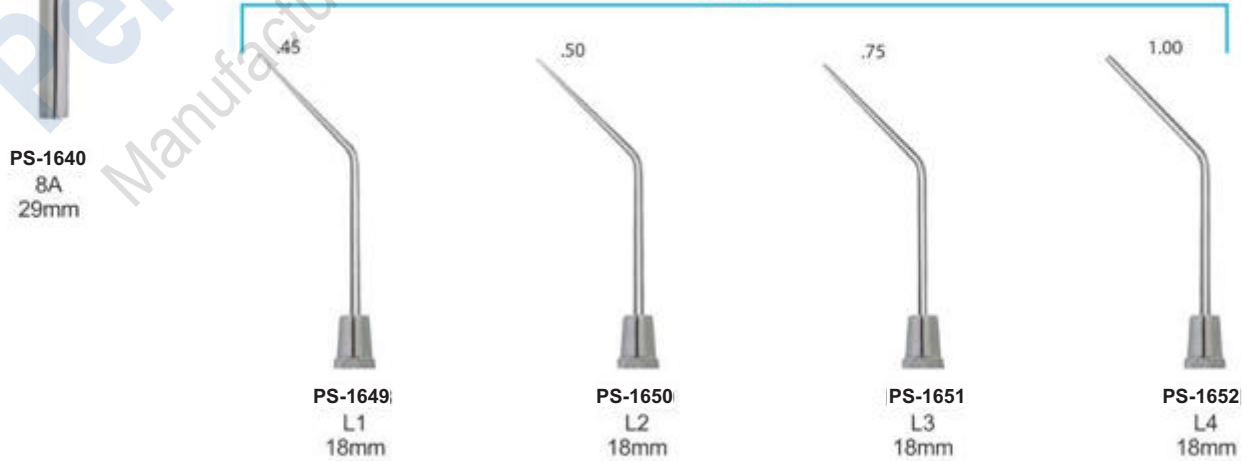



PS-1653
Gracey Curettes 1/2



PS-1654
Gracey Curettes 3/4



PS-1655
Gracey Curettes 5/6



PS-1656
Gracey Curettes 7/8



PS-1657
Gracey Curettes 9/10



PS-1658
Gracey Curettes 11/12



PS-1659
Gracey Curettes 13/14



PS-1660
Gracey Curettes 1/2



PS-1661
Gracey Curettes 3/4



PS-1662
Gracey Curettes 5/6



PS-1663
Gracey Curettes 7/8



PS-1664
Gracey Curettes 9/10



PS-1665
Gracey Curettes 11/12



PS-1666
Gracey Curettes 13/14



GRACEY MINI FIVE

Hollow Handle 9.5mm, Length 170mm Ceramic Coated Handle



PS-1668
Fig. 3/4 Gracey 3M



PS-1669
Fig. 5/6 Gracey 3M



PS-1670
Fig. 7/8 Gracey 3M
Buccal and lingual/
Palatal surfaces



PS-1671
Fig. 11/12 Gracey 3M
Mesial



PS-1672
Fig. 13/14 Gracey 3M
Distal

PS-1667
Fig. 1/2
Gracey 3m

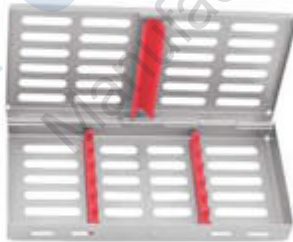

GRACEY AFTER FIVE

Hollow Handle 9.5mm, Length 170mm Ceramic Coated Handle



PS-1674
Gracey 3/4 AF



PS-1675
Gracey 5/6 AF



PS-1676
Gracey 7/8 AF



PS-1677
Gracey 11/12 AF



PS-1678
Gracey 13/14 AF

PS-1673
Gracey
1/2 AF

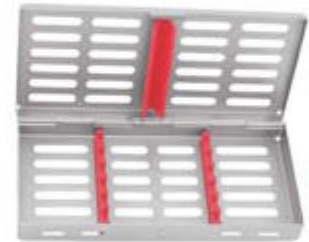

Gracey Curettes



3...1	1...3
3...1	1...3

PS-1679 Fig. 1/2 GR - Gracey
Buccal surfaces



5...1	1...5
5...1	1...5

PS-1680 Fig. 3/4 GR - Gracey
Lingual/Palatal surfaces



5...1	1...5
5...1	1...5

PS-1681 Fig. 5/6 GR - Gracey



8...4	4...8
8...4	4...8

PS-1682 Fig. 7/8 GR - Gracey
Buccal and lingual/
palatal surfaces



8...4	4...8
8...4	4...8

PS-1683 Fig. 9/10 GR - Gracey
Buccal and lingual/
palatal surfaces more angled



8...4	4...8
8...4	4...8

PS-1684 Fig. 11/12 GR - Gracey
Mesial



8...4	4...8
8...4	4...8

PS-1685 Fig. 13/14 GR - Gracey
Distal



8...4	4...8
8...4	4...8

PS-1686 Fig. 15/16 GR - Gracey
Mesial



8...4	4...8
8...4	4...8

PS-1687 Fig. 17/18 GR - Gracey
Distal



■ # 112 - # 134 - # 136
■ # 708 - # 910
■ # 1112 - # 1314
■ # 1316 - # 1318

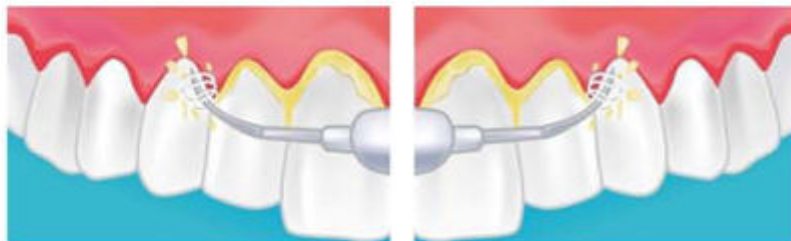

■ # 112 - # 134 - # 136
■ # 708 - # 910
■ # 1112 - # 1314
■ # 1316 - # 1318

SCALER

Sickle Scalers



PS-1688 Fig. U15/33 - Towner-Jaquette



PS-1689 Fig. U15/30 - Towner-Jaquette



PS-1690 Fig. H5/33



PS-1691 Fig. H6/H7



PS-1692 Fig. 30/33 - Jaquette



PS-1693 Fig. T2/T3 - Taylor



PS-1694 Fig. 204



PS-1695 Fig. 204S



PS-1696 Fig. 11/12 - MC - McCall
Mesial



PS-1697 Fig. 13/14 - MC - McCall
Distal

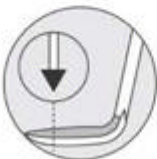

Straight and curved sickle scalers
Feature: 2 cutting edges curved facial component tipped ends



Universal curettes
are characterized by an angle of 90° between the terminal stem and the cutting component.



Gracey curettes
are characterized by an angle of 70° between the terminal stem and the cutting component.

Universal Curettes



PS-1698 Fig. 13S/14S - MC - McCall



PS-1699 Fig. 17S/18S - MC - McCall
Distal



PS-1700 Fig. M23



PS-1701 Fig. 204SD



PS-1702 Fig. YG7/8-Younger Good



PS-1703 Fig. L 1/2 - Langer



PS-1704 Fig. L 3/4 - Langer



PS-1705 Fig. L 5/6 - Langer



PS-1706 Fig. M 23A



PS-1707 Fig. M 23B



Straight and curved sickle scalers
Feature: 2 cutting edges curved facial component tipped ends



Universal curettes
are characterized by an angle of 90° between the terminal stem and the cutting component.

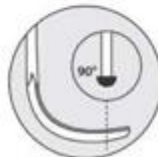

Gracey curettes
are characterized by an angle of 70° between the terminal stem and the cutting component.

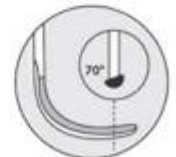

Periodontal knives





PS-1716
17



PS-1717
17D



PS-1718
54A
Mühlemann



PS-1719
67



PS-1720
37D



PS-1721
8
Wiland



PS-1722
8
Holz

0.9 MM

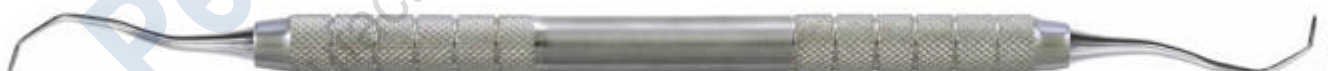

PS-1723
9
Holz

0.7 MM

Chisels
Diamond coated margin trimmers

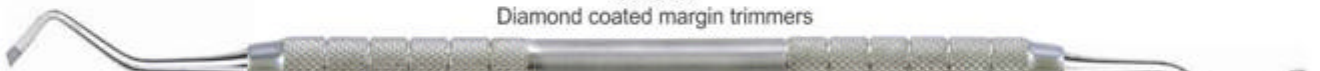

PS-1724
40P



PS-1725
40A

Thanks to the diamond-coated hand instruments the margins are evenly levelled.

Margin trimmers



CHISELS



PS-1739
1/2 Werdelstaedt



PS-1740
3/4 Werdelstaedt



PS-1741
7 Straight



PS-1742
5/6 Straight



PS-1743
7/10 Straight



PS-1744
8/9 Binangle



PS-1745
11/12 Binangle



PS-1746
40/41 Binangle

Tartar Remover Instruments Solid Handle Ø 6 mm



PS-1747
Fig. 1



PS-1748
Fig. 1L
Left

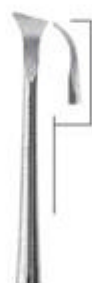

PS-1749
Fig. 1R
Right



PS-1750
Fig. 2L
left



PS-1751
Fig. 2R
Right



PS-1752



PS-1753



PS-1754

BURNISHERS CONSERVATIVE TREATMENT



PS-1755
WHITE 28



PS-1756
WHITE 29



PS-1757
WHITE 31



PS-1758
WHITE 32



PS-1759
WHITE 33



PS-1760
WHITE 34



PS-1761
WESTCOTT 21

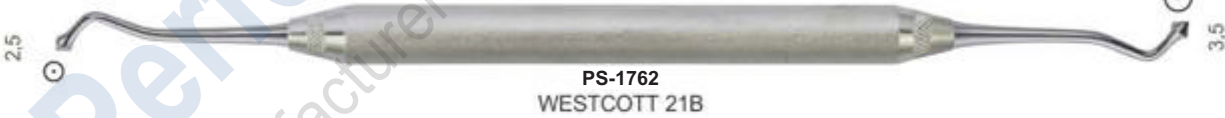

PS-1762
WESTCOTT 21B



PS-1763



PS-1764



PS-1765
WHITE



PS-1766
WHITE

FILLING INSTRUMENTS CONSERVATIVE TREATMENT



PS-1767



PS-1768



PS-1769



PS-1770



PS-1771



PS-1772



PS-1773



PS-1774

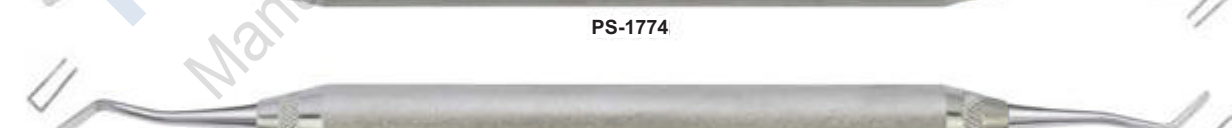

PS-1775

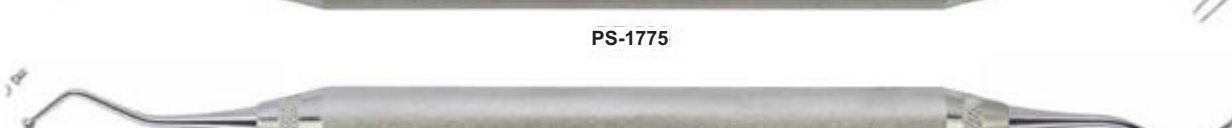

PS-1776

PLANATOR

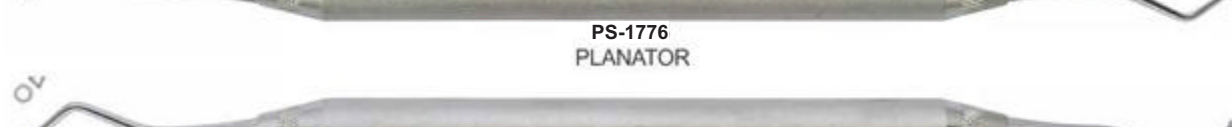

PS-1777

PLANATOR



PS-1778



PS-1779



PS-1780



PS-1781



PS-1782



PS-1783



PS-1784



PS-1785



Ball Burnishers



PS-1786



PS-1787



PS-1788



PS-1789



Hatches



PS-1790



PS-1791



PS-1792
Mini-Spatel



PS-1793
Mini-Spatel

Spatulas rounded and sharp

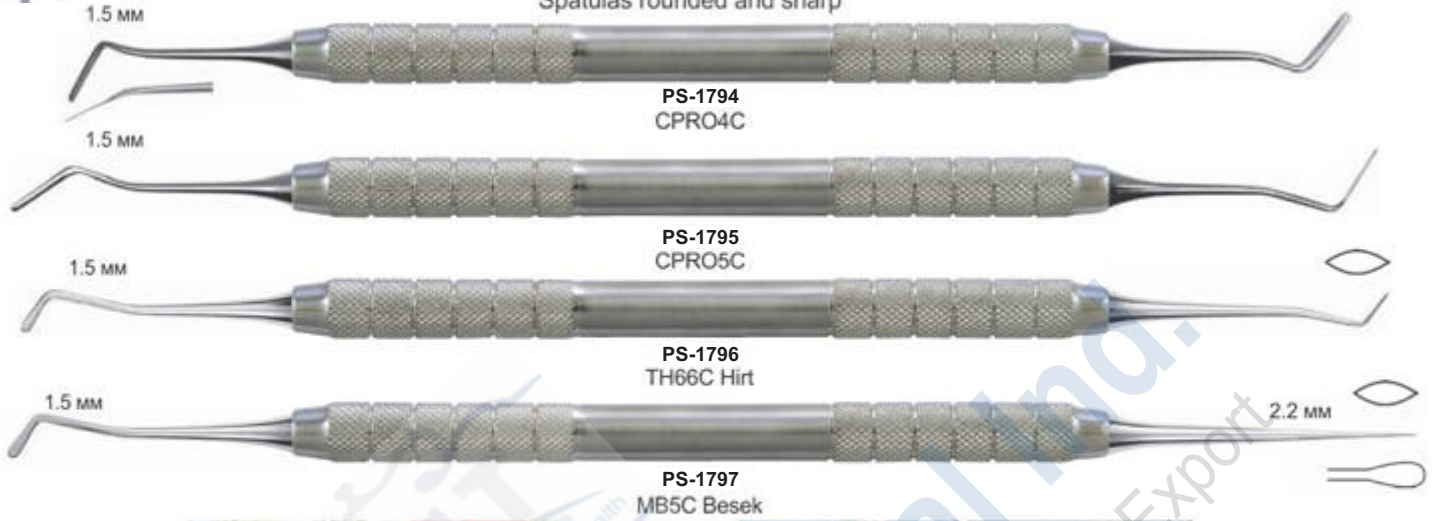

Spatulas Blade Thickness 0.22 mm



Spatulas



Spatulas-Pluggers



EXCAVATOR INSTRUMENTS

Water drop Our excavators have particularly sharp blades, free of burrs and perfectly rounded.

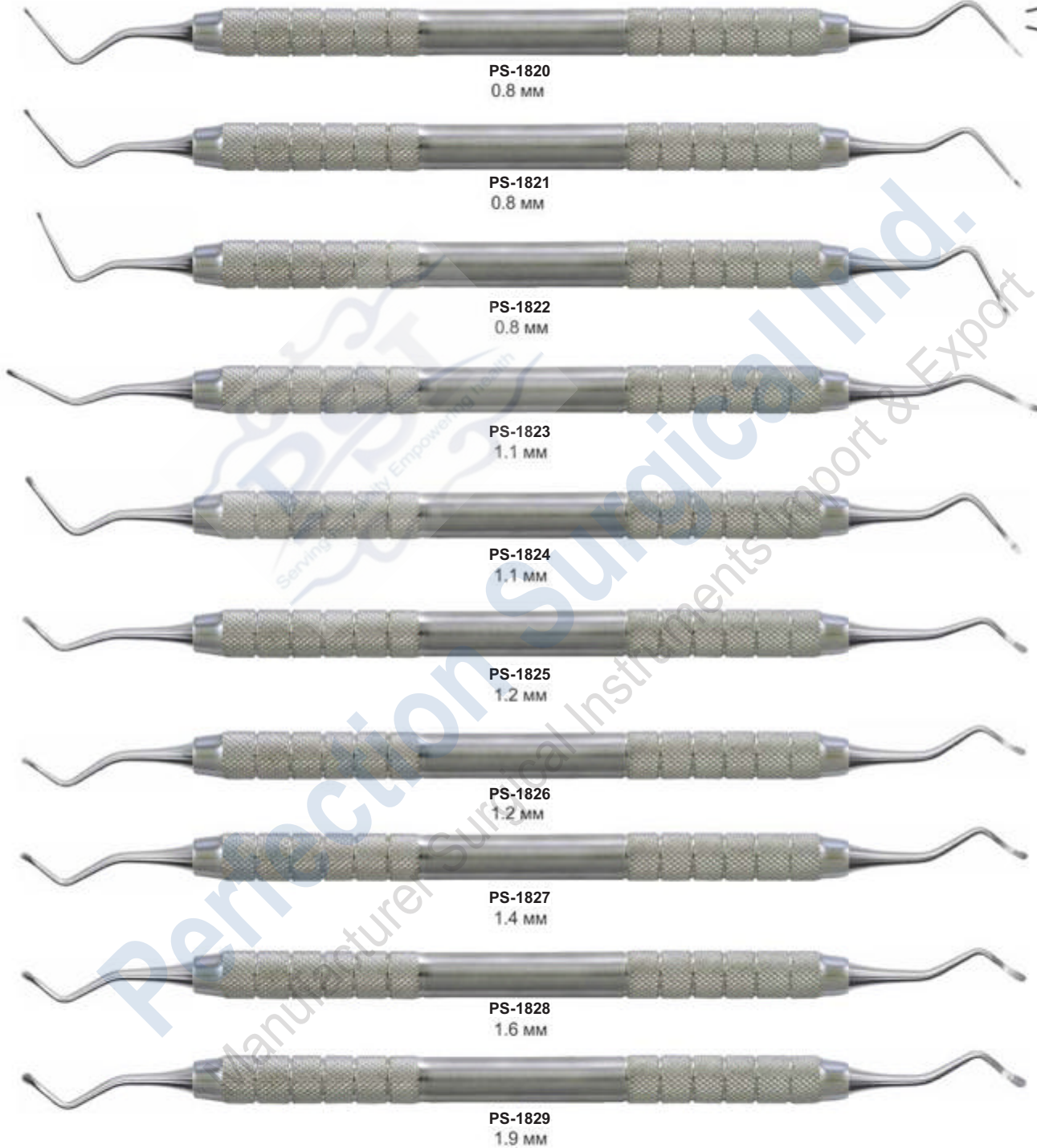



PS-1830



PS-1831

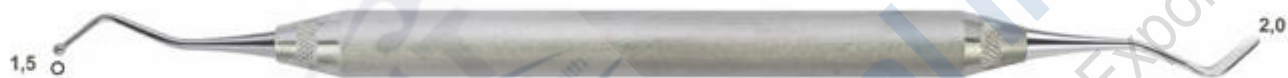

PS-1832



PS-1833



PS-1834



PS-1835



PS-1836



PS-1837



COMPOSITE BALL PLUGGERS



- ø 0.8 MM

PS-1838
Br086

ø 0.6 MM
- ø 1.0 MM

PS-1839
27SBR27SS

ø 0.8 MM
- ø 1.3 MM

PS-1840
27BR27S

ø 1.0 MM
- ø 1.7 MM

PS-1841
26BR27

ø 1.3 MM
- ø 2.3 MM

PS-1842
25BR26

ø 1.7 MM
- ø 2.7 MM

PS-1843
24BR25

ø 2.3 MM
- ø 0.8 MM

PS-184
08BR06

ø 0.6 MM
- ø 1.0 MM

PS-1845
10BR08

ø 0.8 MM
- ø 2.3 MM

PS-1846
MB6C Besek

ø 0.6 MM
- ø 1.3 MM

PS-1847
127C

ø 1.0 MM
- ø 1.7 MM

PS-1848
126C

ø 1.3 MM
- ø 2.3 MM

PS-1849
125C

ø 1.7 MM
- ø 2.7 MM

PS-1850
124C

ø 2.3 MM
- ø 3.2 MM

PS-1851
123C

ø 2.7 MM
- ø 3.2 MM

PS-1852
AP3C

ø 1.7 MM

FILLING INSTRUMENTS CONSERVATIVE TREATMENT

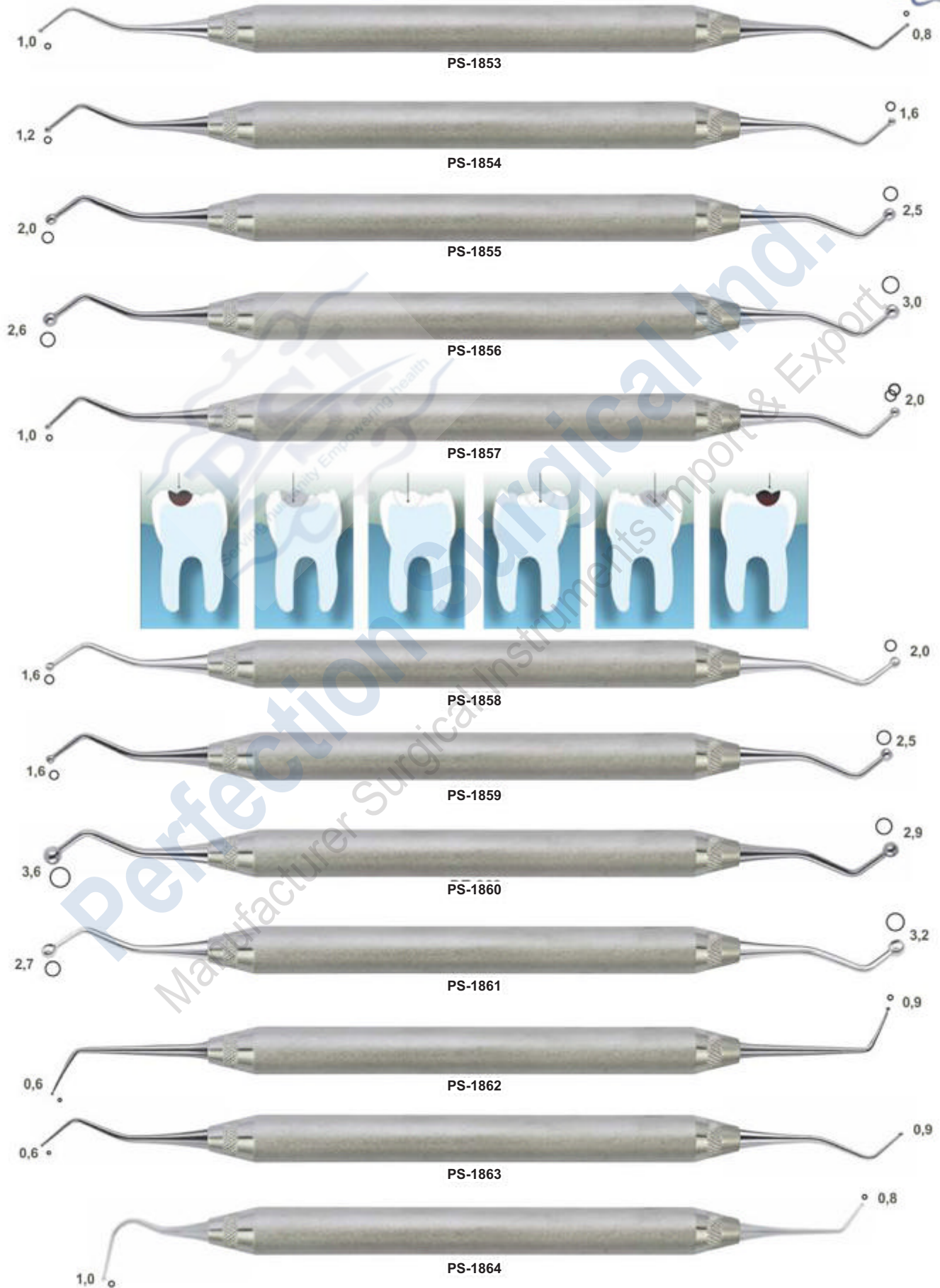



FILLING INSTRUMENTS CONSERVATIVE TREATMENT



PS-1875



PS-1876



PS-1877



PS-1878



PS-1879



PS-1880



PS-1881



PS-1882

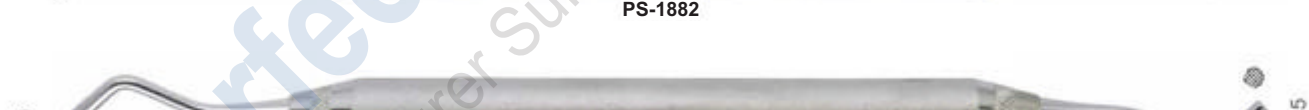

PS-1883



PS-1884

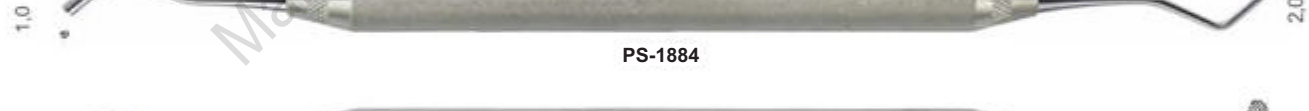

PS-1885

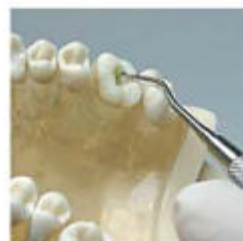



**PS-1886
BLACK**



**PS-1887
BLACK**



**PS-1888
BLACK**



**PS-1889
BLACK**

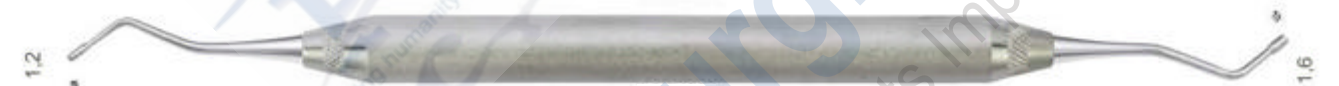

**PS-1890
BLACK**



**PS-1891
HOLLENBACK**

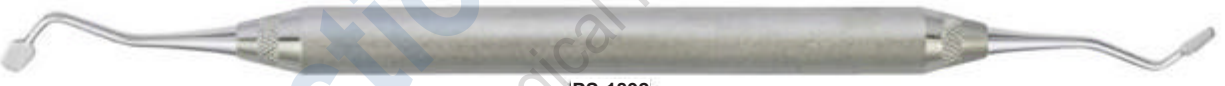

**PS-1892
HOLLENBACK**



**PS-1893
MORTENSON**



**PS-1894
WARD 2**



**PS-1895
WARD 3**



FILLING INSTRUMENTS CONSERVATIVE TREATMENT

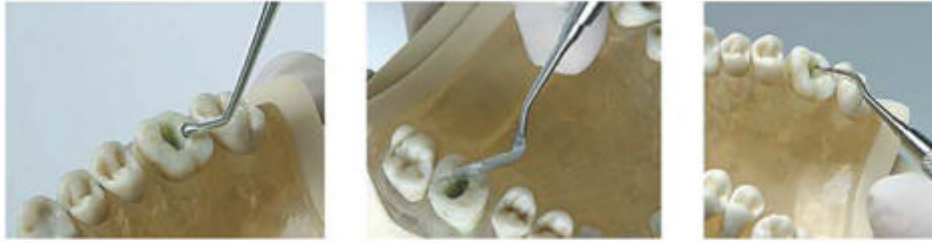

PS-1896
WILLIAMS



PS-1897
WILLIAMS



PS-1898
WILLIAMS



PS-1899



PS-1900



PS-1901



PS-1902



PS-1903



PS-1904



PS-1905



COMPOSITE PLUGGERS INSTRUMENTS



Serrated Pluggers



Ø 0.9 MM		PS-1925 OP36M	Ø 1.2 MM
Ø 1.1 MM		PS-1926 OP36D	Ø 1.6 MM
Ø 1.6 MM		PS-1927 Op36	Ø 2.2 MM
Ø 1.0 MM		PS-1928 Op52	Ø 1.7 MM
Ø 2.2 MM		PS-1929 Zi51	Ø 2.6 MM
Ø 1.8 MM		PS-1930 Op44	Ø 2.2 MM
Ø 1.7 MM		PS-1931 1BR2	Ø 2.6 MM
Ø 2.6 MM		PS-1932 2BR3	Ø 3.6 MM



COMPOSITE MODELLING INSTRUMENTS



PS-1933 MF2C
Fuzzi



PS-1934
Pj4



PS-1935 MB3C
Besek

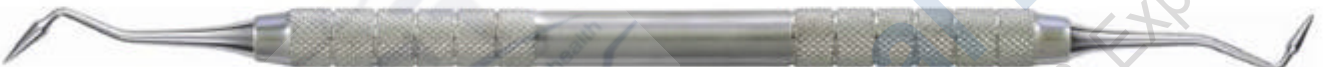

PS-1936
HZ3C



PS-1937
CPRO3C



PS-1938 Mo1
Monari



PS-1939 TH28C
Hirt



PS-1940
HZ25C



PS-1941
Ck10



PS-1942
CK28BC



PS-1943 Op37
Carver



PS-1944
28BR29

Round excavators

Cariology

- for the removal of softened, carious dentin
- for the removal of temporary fillings

Surgery

- to sever the periodontal ligament prior to extraction
- for the removal of granulation tissue after extraction

Design: Round working end Curved cutting edge



Round Excavator, 1.0 mm
PS-1945



Round Excavator, 1.5 mm
PS-1946

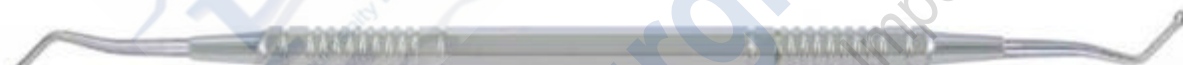

Round Excavator, 2.0 mm
PS-1947

Triple-angled back action excavators



Triple-angled Back Action Excavator, 1.0 mm
PS-1948



Triple-angled Back Action Excavator, 1.5 mm
PS-1949



Triple-angled Back Action Excavator, 2.0 mm
PS-1950



Triple-angled Back Action Excavator, 3.5 mm
PS-1951



FILLING INSTRUMENTS



- Инструменты для реставрации
- Instruments pour plombage
- Füllungsinstrumente (mit Kontrawinkel)
- Инструменти для реставрації
- Instrumentos para obturaciones
- ملء الصكوك

COMPOSITE/PLASTIC FILLING INSTRUMENTS SOLID HANDLE 6MM, LENGTH 170MM

BLACK

PLUGGERS/CONDENSERS

Hollenback

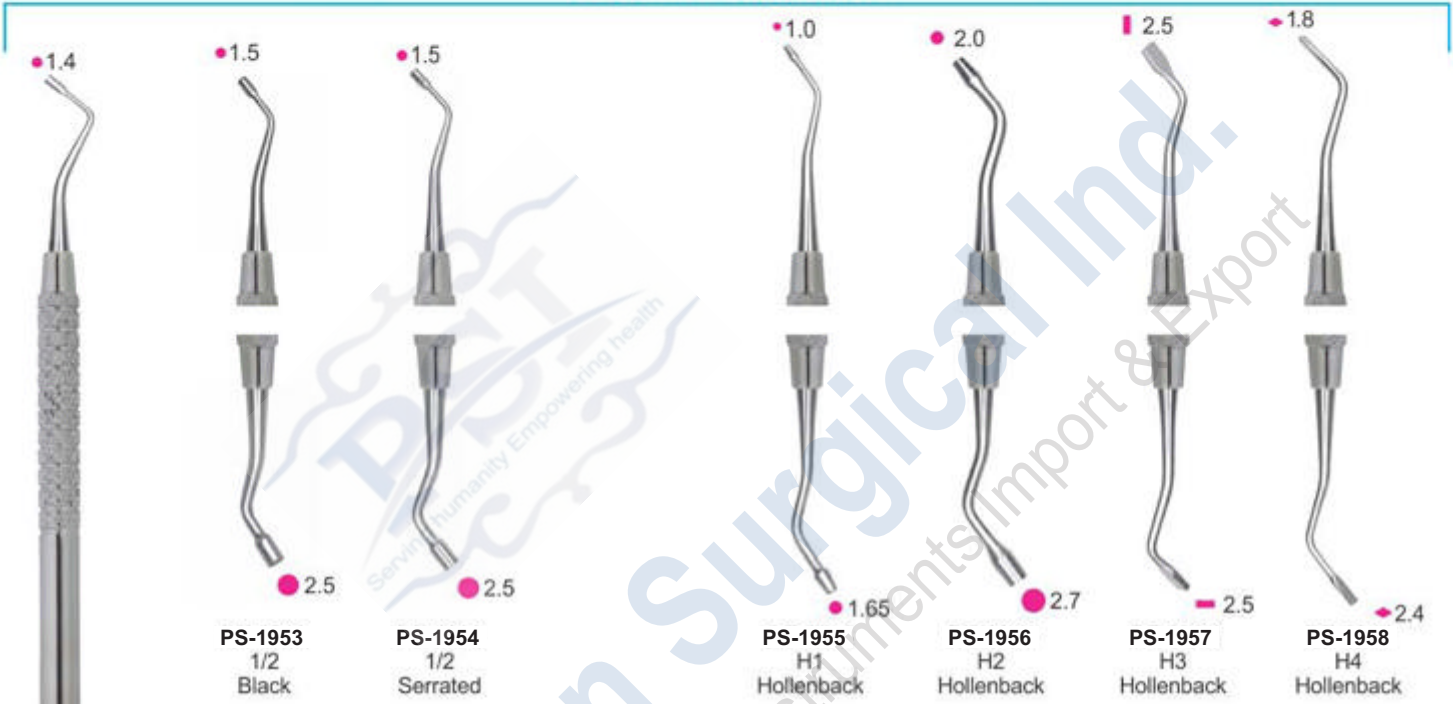

PS-1953
1/2
Black

PS-1954
1/2
Serrated

PS-1955
H1
Hollenback

PS-1956
H2
Hollenback

PS-1957
H3
Hollenback

PS-1958
H4
Hollenback

MARQUETTE CONDENSER

MORTONSON

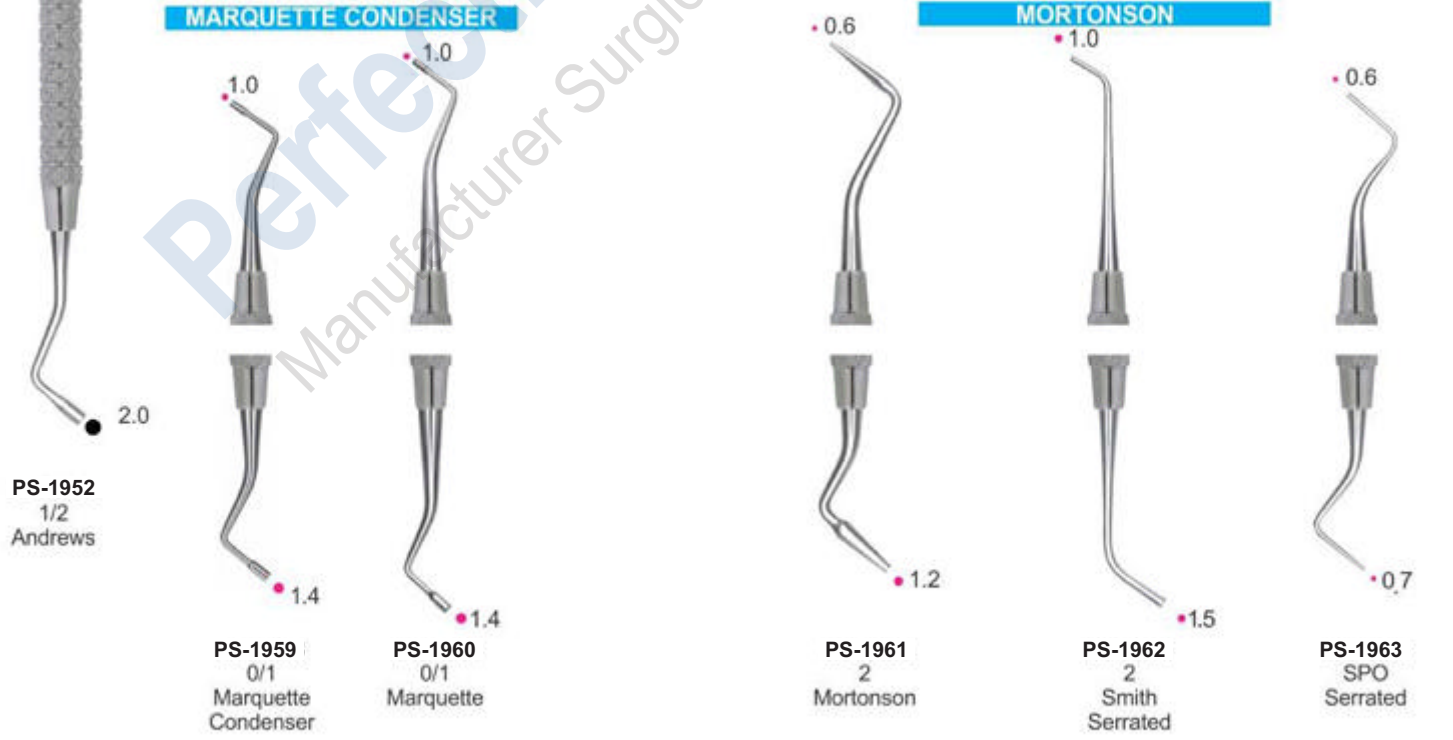

PS-1952
1/2
Andrews

PS-1959
0/1
Marquette
Condenser

PS-1960
0/1
Marquette

PS-1961
2
Mortonson

PS-1962
2
Smith
Serrated

PS-1963
SPO
Serrated

FILLING INSTRUMENTS

- Инструменты для реставрации
- Instruments pour plombage
- Füllungsinstrumente (mit Kontrawinkel)
- Инструменти для реставрації
- Instrumentos para obturaciones
- ملء الصكوك

RESTORATIVE INSTRUMENTS SOLID HANDLE 6MM, LENGTH 170MM Back Action Filling Instruments

Tanner Filling Instruments



PS-1965
2T
Tanner

PS-1966
3T
Tanner

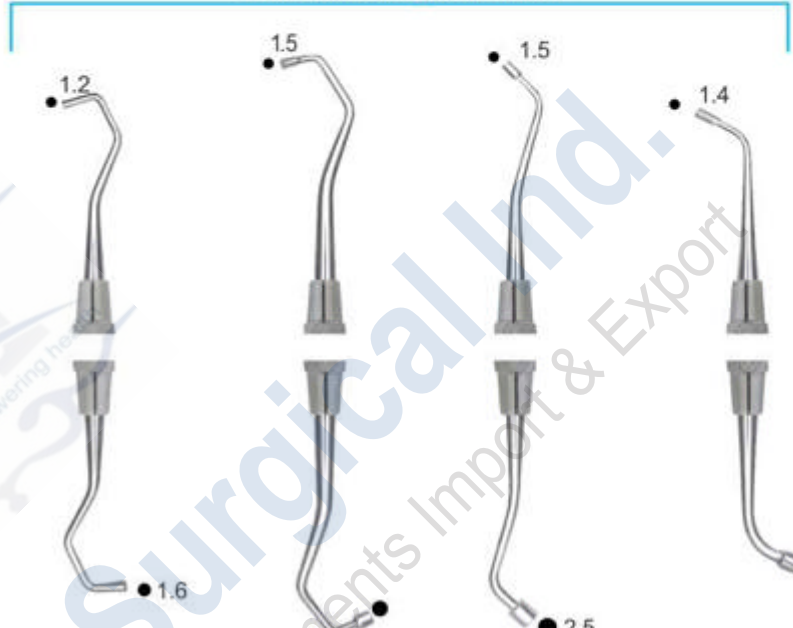

PS-1967
9/10
Back Action

PS-1968
11/12
Back Action

PS-1969
153
English Pattern
Serrated

PS-1970
153
English Pattern
Serrated

BURNISHERS



PS-1971
18

PS-1972
26/27S

PS-1973
27/29

BEAVERTAIL



PS-1974
2

PS-1975
2
Double-End

ACORN



PS-1976
21

PS-1977
21B

LADMORE



PS-1978
2
Ladmore

PS-1964
1T
Tanner

CARVERS INSTRUMENTS



- Инструменты для реставрации
- Instruments a modeler
- Modellierinstrumente
- Инструменти для реставрації
- Instrumentos para modelar
- أدوات تظهير

P.K. THOMS WAXING INSTRUMENTS SOLID HANDLE 6mm



PS-1985
Composite Instruments Blue
Titanium with Cassettes



PS-1986
P.k. Thomas Waxing Instruments Kit

COMPOSITE INSTRUMENTS TITANIUM BLUE ENDODONTIC

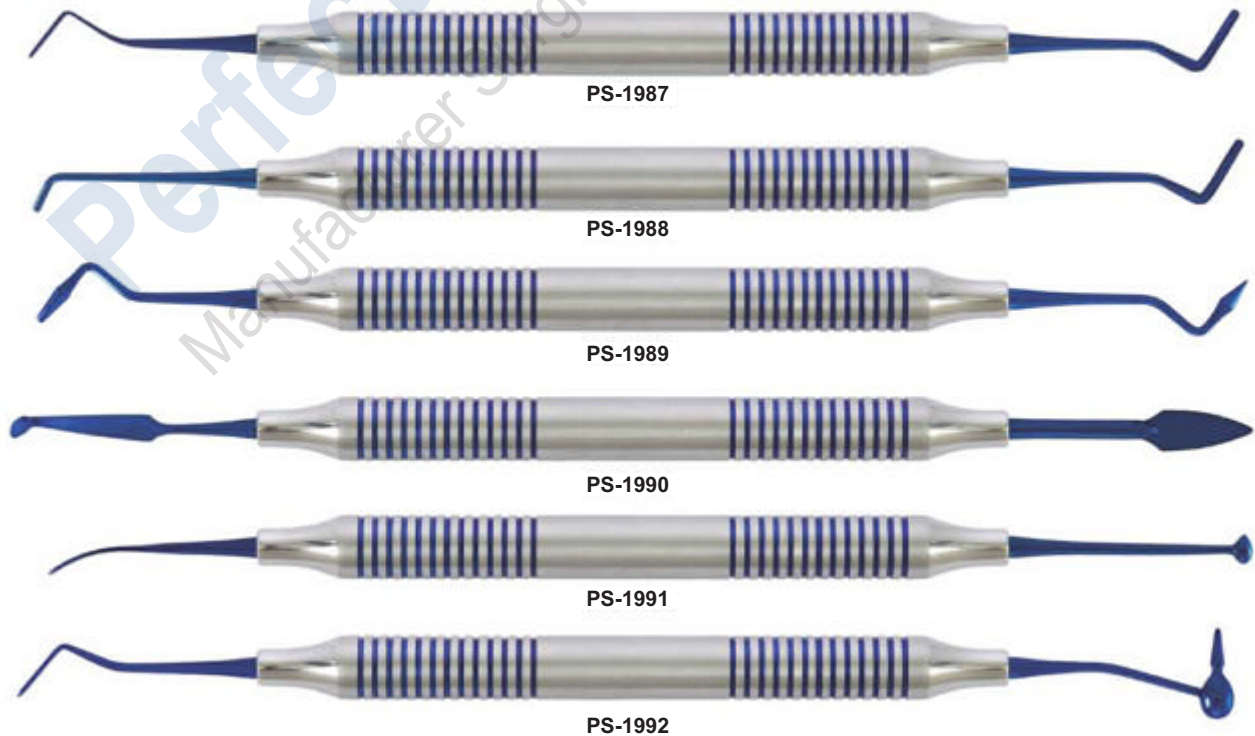

CARVERS INSTRUMENTS

- Инструменты для реставрации
- Instruments a modeler
- Modellierinstrumente
- Инструменти для реставрації
- Instrumentos para modelar
- أدوات تقطيع



PS-1993

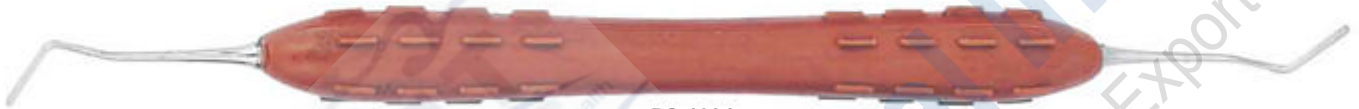

PS-1994



PS-1995



PS-1996



PS-1997

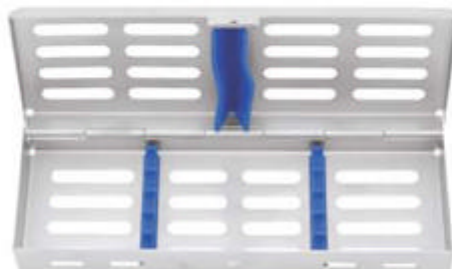

Cassette For 5 Instruments
PS-1998

FILLING INSTRUMENTS



- Инструменты для реставрации
- Instruments pour plombage
- Füllungsinstrumente (mit Kontrawinkel)
- Инструменти для реставрації
- Instrumentos para obturaciones
- ملء الصكوك

FILLING INSTRUMENTS (Gold Pointed) SOLID HANDLE 6MM, LENGTH 170MM



PS-1999 1.5mm / 1.5mm

PS-2000 2.0mm / 2.0mm

PS-2001 2.0mm / 2.0mm

PS-2002 2.5mm / 2.5mm

PS-2003 1.3mm / 0.9mm

PS-2004 1.6mm / 1.3mm

PS-2005 2.4mm / 1.8mm

PS-2006 2.4mm / 2.0mm

PS-2007 1.3mm / 1.5mm

PS-2008 1.8mm / 1.2mm

Filling instrument, spatula 6 mm solid handle, length 170 mm,

Filling instrument 6 mm length 175 mm,

Filling instrument, ball 6 mm length 170 mm,

Filling instrument, ball / spatula 6 mm length 175 mm,

Filling instrument, plan / plan 6 mm length 165 mm,

COMPOSITE FILLING INSTRUMENTS

- Инструменты для реставрации
- Instruments pour plombage
- Füllungsinstrumente (mit Kontrawinkel)
- Инструменти для реставрації
- Instrumentos para obturaciones
- ملء الصكوك

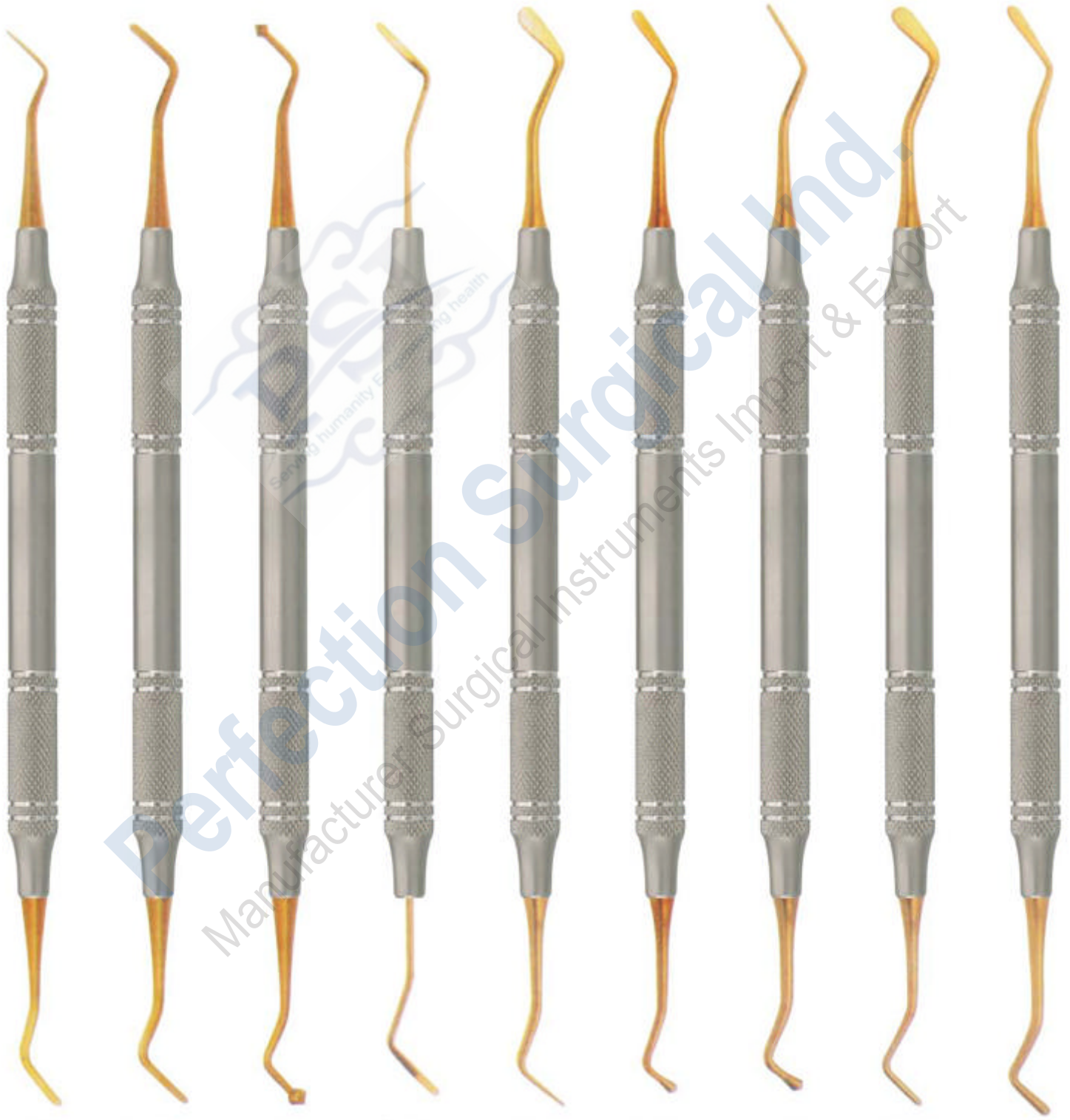

PS-2009

PS-2010

PS-2011

PS-2012

PS-2013

PS-2014

PS-2015

PS-2016

PS-2017

COMPOSITE FILLING INSTRUMENTS



- Инструменты для реставрации
- Instruments pour plombage
- Füllungsinstrumente (mit Kontrawinkel)
- Инструменти для реставрації
- Instrumentos para obturaciones
- ملء الصكوك

Composite Gold Tip Instruments



MISCELLANEOUS PRODUCTS

- Прочие товары
- Divers produits et services
- Sonstige Produkte
- Інші товари
- Varios Productos
- المنتجات المتنوعة



PS-2029
X Ray Film Hangers



PS-2030
X Ray Film Hangers



PS-2031
X Ray Film Hangers



PS-2032
X Ray Film Hangers



PS-2033
X Ray Film Hangers



PS-2034
X Ray Film Hangers



PS-2035
X Ray Film Hangers



PS-2036



PS-2037



PS-2038



Dissecting Set
PS-2039 Set of 9 Pcs.
PS-2040 Set of 11 Pcs.



PS-2041
Napkin holder with metal chain

PS-2042
Napkin Holder with Plastic Chain



Mouth Props
PS-2043
Small

Mouth Props
PS-2044
Medium

Mouth Props
PS-2045
Large

Key Rings



PS-2046



PS-2047



PS-2048



PS-2049



PS-2050



PS-2051

CEMENT SPATULAS

- Шпатели для цемента
- Spatules à ciment
- Zementspatel
- Шпатели для цементу
- Espátulas para cemento
- ملاعق الأسمنت



WAX KNIVES

- Ножи для воска
- Couteaux a cire
- Wachsmesser
- Ножи для воску
- Cuchillos para cera
- المسكين الشمع

ALGINATE, PLASTER SPATULAS, WAX KNIVES PLASTER FOR KNIVES & PLASTER SHEAR



PS-2074
Wooden Handle
Fig. 5
21.5 cm



PS-2075
Wooden Handle
Fig. 7
19.5 cm curved



PS-2076
Wooden Handle
Fig. 8
20 cm curved



PS-2077
Wooden Handle
Fig. 9
22.5 cm curved



PS-2078
Hook Knives



PS-209
Fig. 1
Lessmann
12.5 cm



PS-2080
Fig. 2
Lessmann
17 cm



PS-2081
Fig. 1
with small spoon
12.5 cm



PS-2082
Fig. 2
with large spoon
17 cm



PS-2083
Bacolite Handle
Wax Knives,
Small



PS-2084
Bacolite Handle
Wax Knives,
Large



PS-2085
Wooden Handle
Wax Knives,
Small



PS-2086
Wooden Handle
Wax Knives,
Large



PS-2087
Plaster Knife



PS-2088
Fig. 1
17 cm



PS-2089
Fig. 3
16 cm



PS-2090
Fig. 4
16 cm



PS-2091
Special Inox
19.5 cm

ARTICULATORS



- Артикуляторы
 - Artocilar
 - Artikulations
- Артикулятори
 - Articuler
 - ارتیکولاتورس



PS-2092

Technical Datas:

Intercondylar distance 120 mm.
 condylar inclination fixed at 30°
 Bennet angle fixed at 7°
 Incisal table inclination 10°
 Distance between mounting plates 85 mm.
 Weight 400 gr.
 Opening (item 5000) 125°
 Opening (item 5010) 180°



PS-2093

Technical Datas:

Intercondylar distance 110 mm.
 condylar inclination fixed at 30°
 Bennet angle fixed at 7°
 Incisal table inclination flat
 Distance between mounting plates 85 mm.
 Weight 450 gr.
 Opening 180°



PS-2094

Stainless Steel Finishing

PS-2095

Royal Blue



PS-2096



PS-2097



PS-2098



PS-2099



PS-2100



PS-2101



PS-2102



PS-2103



PS-2104



PS-2105
 Nakawalni
 Dental Laboratory
 Instrument



PS-2106 Adult Palatal /
PS-2107 Child Palatal



PS-2108
Buccal



PS-2109 Adult Palatal /
PS-2110 Child Palatal



PS-2111 Adult Palatal /
PS-2112 Adult Buccal



PS-2113 Lingual upper /
PS-2114 Lingual Lower

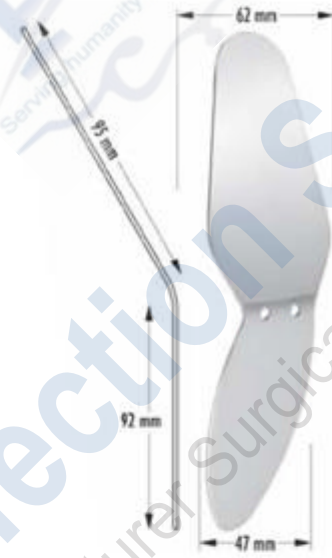

PS-2115 Adult Buccal /
PS-2116 Child Buccal



PS-2117 Child Palatal /
PS-2118 Child Buccal



DE-1228
Palatal-Adult



PS-2119
Palatal-Adult Large



PS-2120
Palatal-Child



PS-2121
Buccal-Small



PS-2122
Buccal



PS-2123
Lingual



PS-2124
Lingual-Large

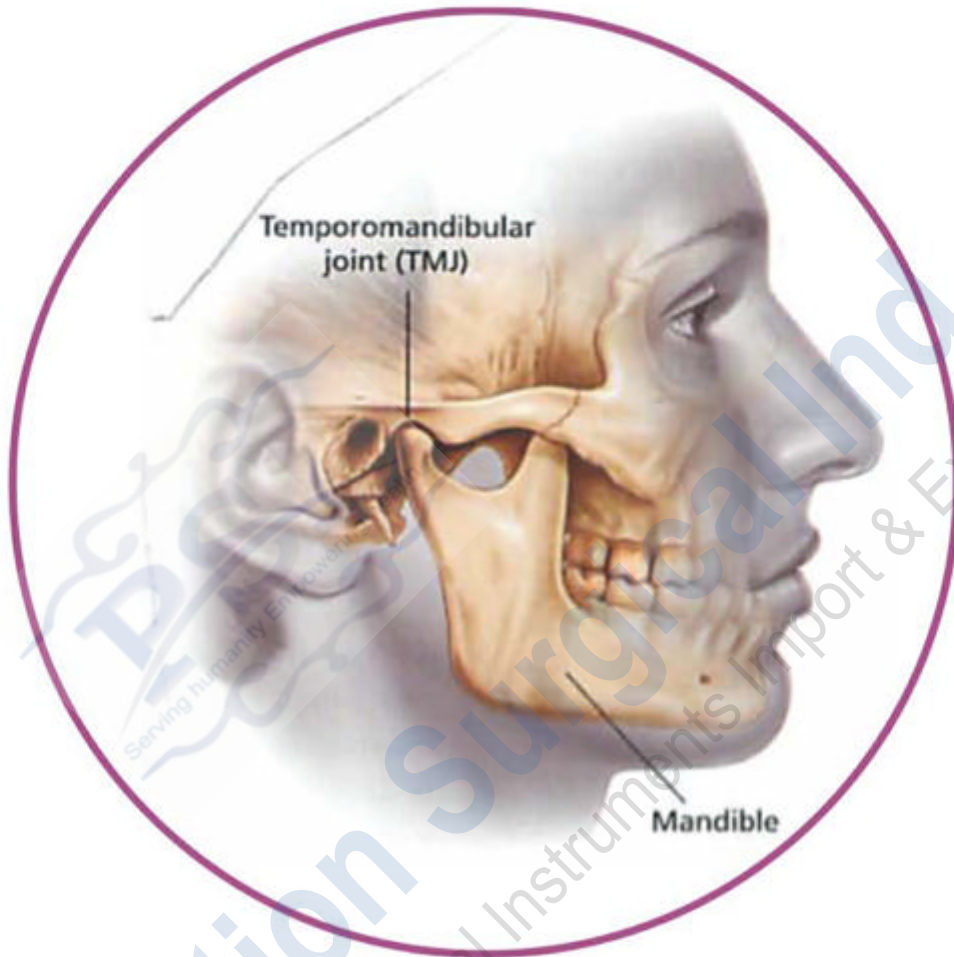

RETRACTORS - MOUTH GAGS

- Роторасширители
- Ecarteurs - Ouvre-bouches
- Vestibulumabhalter / Mundspanner
- Роторозширювачі
- Separadores - Abre-bocas
- الفكاشات - الفكاشات الفم



PS-2125
HMG
Heister
130mm



PS-2126
Mouth Gag Molt
11 cm for (Children)



PS-2127
Mouth Gag Molt
14 cm for (Adults)



Sternberg Retractors
PS-2128 140 mm
PS-2129 180 mm



Columbia Retractor
PS-2130 140 mm



PS-2131
Wangen Holder
vestibule
15 cm, with or without
lip protection,



PS-2132
Wangen Holder
vestibule 15 cm, with
or without lip protection



PS-2133
Wangen Holder
with dual
function, 17 cm



Weider Retractor

PS-2134
140 mm

PS-2135
150 mm

RETRACTORS - MOUTH GAGS



- Роторасширители
- Роторозширювачі
- Ecarteurs - Ouvre-bouches
- Separadores - Abre-bocas
- Vestibulumabhalter / Mundspanner
- الكاشحات - الكمامات الفم



Weitlaner
Fig. 1
PS-2136 10.5cm
PS-2137 13.5cm



Weitlaner
Fig. 2
PS-2138 10.5cm
PS-2139 13.5cm



PS-2140
Lip & Cheek Retractor
Stainless Steel
Double Ended



PS-2141
Simplex Retractor
Stainless Steel
Single Ended



Weitlander
PS-2142 11cm
PS-2143 13cm
PS-2144 15cm



PS-2148
Denhard
12 cm



PS-2149
Roser-König
16 cm



PS-2150
Roser-König
19 cm



Jennings
PS-2145 11cm
PS-2146 13cm
PS-2147 15cm

RETRACTORS

- Ранорасширители
 - Ecarteurs
 - Wundhaken
- Ранорозширювачі
 - Separadores
 - الكاشطات

Wound, Bendable
Retractor, individually or as saving kit!



PS-2151
Cheek Retainer
One-sided
Long



PS-2152
Cheek Retainer
One-sided
Long



PS-2153
Cheek Retainer
One-sided
Long



**Ergo Grip
Retractor**
PS-2154 24 cm
ergonomic handle,



Ivory Retractors
Width adjustable
& fixable,
PS-2155 | 20 cm



Bruenings Retractors
tongue depressors
PS-2156 19 cm



**Minnesota
Retractors**
PS-2157 16 cm



Ribbon Retractors
PS-2158 20 cm
easy to bend
by hand,



Bishop Retractors
retractor and tongue
pushers Bishop with
comfortable margin
PS-2159 16 cm



**Combination
Retractors**
PS-2160 25 cm

RETRACTORS



- Ранорасширители
 - Ecarteurs
 - Wundhaken
- Ранорозширювачі
 - Separadores
 - الكاشحات



PS-2161
Unique Retractors
Length 175 mm
angled 45 °



PS-2162
Unique Retractors
Length 175 mm
angled 90°



PS-2163
Retractors
16cm



PS-2164
Retractors
19cm



PS-2165
Mini-Langenbeck
Retractors
16 cm, hooks 22 mm



PS-2166
US army Retractors
21 cm, 2



PS-2167
ALM Retractor
about 8 cm



PS-2168
Senn Mueller Retractor
17 cm, hooks 22 mm

RETRACTORS

- Ранорасширители
 - Ecarteurs
 - Wundhaken
- Ранорозширювачі
 - Separadores
 - الكاشطات



PS-2169
Langenbeck Retractors
surgical-flat
21 cm, hook
30x16 mm



PS-2170
Langenbeck Retractors
surgical-flat
21 cm, hook
42x11 mm



PS-2171
Langenbeck Retractors
surgical-flat
21 cm, hook
63x12 mm



Langenbeck Retractors
surgical-flat
21 cm, hook
PS-2172 30x16 mm
PS-2173 42x11 mm
PS-2174 63x12 mm



Langenbeck Retractors
21 cm, hook
PS-2175 30x11 mm
PS-2176 30x16 mm



PS-2177
Middelborpf
Retractors
21 cm



PS-2178
Farabeuf
(120 X 12mm
Set of 2 pices)



PS-2179
Retractor Seldin



PS-2180
Feldman Retractor
14cm

GUM SCISSORS



- Ножницы десневые
 - Ciseaux a gencives
 - Zahnfleischscheren
- Ножницы для ясен
 - Tijeras para encias
 - مقص صمغ



PS-2181
Iris
115mm
Straight



PS-2182
Iris
115mm
Curved



PS-2183
Goldman-Fox
130mm
Saw edge, straight



PS-2184
Goldman-Fox
130mm
Saw edge, Curved



PS-2185
La Grange
115mm
Saw edge, double Curved



Mayo
PS-2186 140mm
PS-2187 170mm
PS-2188 230mm
Straight



Mayo
PS-2189 140mm
PS-2190 170mm
PS-2191 230mm
Curved



Metzenbaum
PS-2192 145mm
PS-2193 180mm
PS-2194 200mm
Straight



Metzenbaum
PS-2195 145mm
PS-2196 180mm
PS-2197 200mm
Curved



PS-2198
Kelly
160mm
Straight



PS-2199
Kelly
160mm
Curved



PS-2200
Iris
115mm
Straight



PS-2201
Iris
115mm
Curved



PS-2202
La Grange
115mm
Double Curved



PS-2203
Goldman-Fox
130mm, Straight



PS-2204
Goldman-Fox
130mm, Curved



PS-2205
Kelly
160mm, Curved



PS-2206
Iris
115mm, Straight



PS-2207
Iris
115mm, Curved



PS-2208
Micro Iris
90mm, Curved

GUM SCISSORS

- Ножницы десневые
- Ciseaux a gencives
- Zahnfleischscheren
- Ножиці для ясен
- Tijeras para encias
- منصص



PS-2209
Iris
115mm
Angled



PS-2210
Iris
115mm
Curved



PS-2211
Goldman-Fox
130mm
Saw edge,
straight



PS-2212
Goldman-Fox
130mm
Saw edge,
curved



PS-2213
Goldman-Fox
130mm
Saw edge,
double curved



PS-2214
La Grange
115mm
Saw edge,
double curved



PS-2215
Neumann
120mm
Saw edge,
double curved



PS-2216
Kilner (Ragnell)
120mm
Straight



PS-2217
Kilner (Ragnell)
120mm
Curved



PS-2218
Joseph
140mm
Straight



PS-2219
Joseph
140mm
Curved



PS-2220
Kelly
160mm
Straight



PS-2221
Kelly
160mm
Curved



PS-2222
Locklin
160mm
Saw edge,
angular



PS-2223
Locklin
120mm
DE-1350
160mm
Saw edge, angular



PS-2224
Dean
170mm
Saw edge,
angular



PS-2225
Spencer
90mm



PS-2226
Spencer
130mm



PS-2227
Spencer
115mm



PS-2228
Noyes
110mm, Straight



PS-2229
Noyes
110mm
Curved



PS-2230
Noyes
110mm
Angular



PS-2231
Castroviejo
150mm
Curved

GUM SCISSORS

- Ножницы десневые
- Ciseaux a gengivas
- Zahnfleischscheren

- Ножиці для ясен
- Tijeras para encias
- منص صمغ

NEEDLE HOLDERS

- Иглодержатели
- Porte-aiguilles
- Nadelhalter

- Голкотримачі
- Porta-agujas
- اصحاب ابرة



PS-2232
130mm
Straight



Mayo Mayo
130mm 130mm
160mm 160mm
180mm 180mm
Straight Curved



PS-2236 140mm 140mm
PS-2237 200mm 200mm
Straight Curved



Metzenbaum
PS-2238 145mm 145mm
PS-2239 200mm 200mm
Straight Curved



PS-2240
Beebee
110mm
Saw edge,
straight



PS-2241
Beebee
110mm
Saw edge,
curved



PS-2242
Beebe
110mm
Saw edge, straight



PS-2243
Beebe
110mm
Saw edge, curved

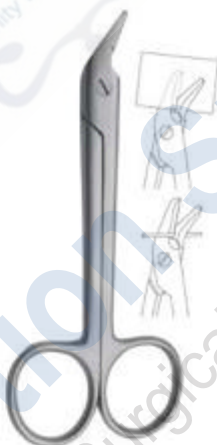

PS-2244
Universal
120mm
Saw edge



PS-2245
Universal
120mm



Ryder
PS-2246 130mm
PS-2247 150mm
PS-2248 180mm



PS-2249
Halsey
130mm

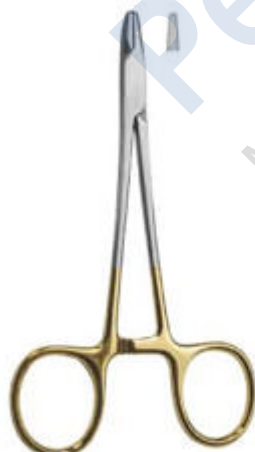

PS-2250
Baumgartner
130mm



PS-2251
Derf
120mm



PS-2252
Delicate
150mm



Mayo-Hegar
PS-2253 130mm
PS-2254 160mm
PS-2255 180mm
PS-2256 200mm



PS-2257
Crile-Wood
150mm
straight



PS-2258
Crile-Wood
150mm
curved

NEEDLE HOLDERS

- Иглодержатели
- Porte-aiguilles
- Nadelhalter

- Голкотримачи
- Porta-agujas
- اصحاب ابرة



Ryder
 PS-2259 130mm
 PS-2260 150mm
 PS-2261 180mm



PS-2262
 Halsey
 130mm



PS-2263
 Baumgartner
 130mm



PS-2264
 Derf
 120mm



PS-2265
 Delicate
 150mm



PS-2266
 Adson
 170mm



Mayo-Hegar
PS-2267 130mm
PS-2268 160mm
PS-2269 180mm
PS-2270 200mm



PS-2271
 Crile-Wood
 150mm



Castroviejo
PS-2272 str 140mm cvd
PS-2273 str 180mm cvd



Olsen-Hegar Needle Holder With Scissors
PS-2274 140mm



Gillies Needle Holder With Scissors
PS-2275 160mm



Mathieu
PS-2276 140mm
PS-2277 170mm



Castroviejo
PS-2278 str 140mm cvd
PS-2279 str 180mm cvd



Olsen-Hegar Needle Holder With Scissors
PS-2280 140mm



Gillies Needle Holder With Scissors
PS-2281 160mm

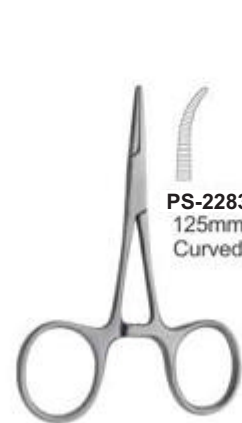

Hartmann (Baby Mosquito)
PS-2282 90mm straight



Halstead Mosquito
PS-2284 125mm Straight

PS-2283
 125mm Curved

PS-2285
 Curved

GUM SCISSORS



- Ножницы десневые
- Ciseaux a gencives
- Zahnfleischscheren
- Ножницы для ясен
- Tijeras para encias
- مقص صمغ



PS-2286
Goldman Fox Scissors
12.5cm Curved



PS-2287
Iris Scissors
11.5cm Curved
Serrated For Slip-Free Cutting



PS-2288
LaGrange Scissors
11.5cm Double Curved
Serrated For Slip-Free Cutting

Double
Curved



PS-2289
Castroviejo Micro Scissors
12cm Curved



PS-2290
Super Cut Goldman Fox
13.2cm Curved
Serrated For Slip-Free Cutting



PS-2291
Super Cut Iris
11cm Straight
Serrated For Slip-Free Cutting



PS-2292
Super Cut LaGrange
11cm Curved
Serrated For Slip-Free Cutting

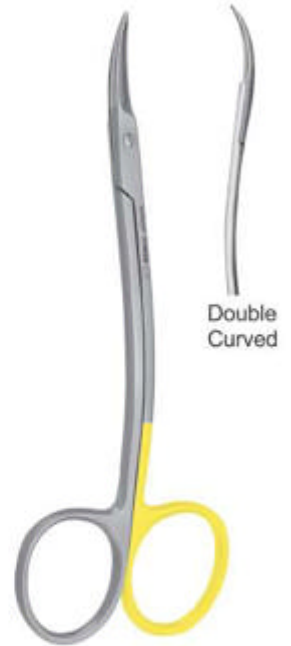

PS-2293
Super Cut LaGrange
11.5cm
Double Curved
Serrated For Slip-Free Cutting

Double
Curved

NEEDLE HOLDERS

- Иглодержатели
- Porte-aiguilles
- Nadelhalter

- Голкотримачи
- Porta-agujas
- اصحاب ابرة



PS-2294
Lichtenberg-
Ryder T.C
14 cm



PS-2295
Lichtenberg-
Ryder T.C
14 cm



PS-2296
Lichtenberg-
Ryder T.C
17 cm



PS-2297
Lichtenberg-
Ryder T.C
17 cm



PS-2298
Barraquer
18 cm



PS-2299
Barraquer
18 cm



PS-2300
Barraquer T.C
18 cm



PS-2301
Barraquer T.C
18 cm



PS-2302
Tönnis
18 cm



PS-2303
Castroviejo
13 cm
Straight



PS-2304
Kalt Needle Holders T.C
14 cm Straight



PS-2306
La Grange
Curved



PS-2305
Peet Splinter Forceps
11.5 cm



PS-2307
All-Purpose Pliers

HAEMOSTATIC FORCEPS & TOWEL CLAMPS



- Зажимы артериальные, зажимы для салфеток
- Pincers hemostatiques, Pincers a compresses
- Arterienklemmen, Tuyschklemmen
- Затискачі артеріальні, затискачі для серветок
- Pinzas hemostaticas, Pincers para compresas
- الملقط هيموستاتيک المشابک منشفه

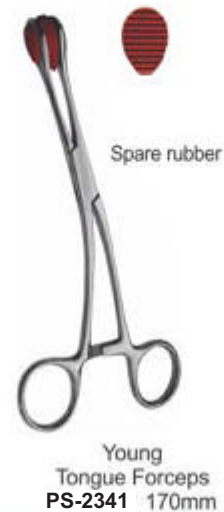
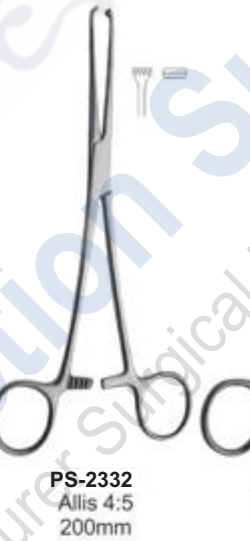
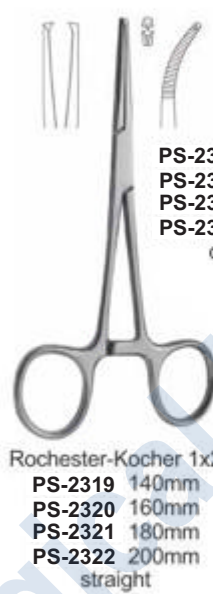
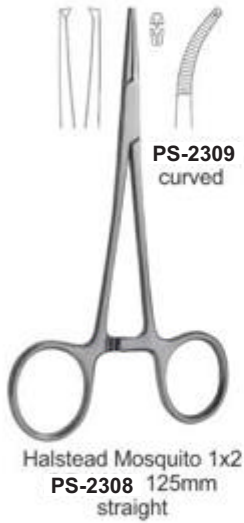

RUBBER DAM CLAMPS FORCEPS

- Инструменты для системы коффердам
- Pincas porte-crampons a digue
- Kofferdam Klammerzangen
- Инструменти для системи коффердам
- Pinzas de engrapar para dique de caucho
- السد العظام الملقط المشابك



PS-2343

On request the Content of the rubber dam kit can be changed with other instruments.

Content:

- 01 Anisworth
- 02 Brewer
- 03 Clamps Stand
- 04 Denture Plate
- 05 Rubber Dam Frame
- 06 Rubber Dam Box Lower Case
- 07 Rubber Dam Box Upper Case
- 08 Rubber Dam Clamp Fig. 212
- 09 Rubber Dam Clamp Fig. 211
- 10 Rubber Dam Clamp Fig. 8
- 11 Rubber Dam Clamp Fig. 8A
- 12 Rubber Dam Clamp Fig. 14
- 13 Rubber Dam Clamp Fig. 14A
- 14 Rubber Dam Clamp Fig. 0
- 15 Rubber Dam Clamp Fig. 00
- 16 Rubber Dam Clamp Fig. 2
- 17 Rubber Dam Clamp Fig. 2A
- 18 Rubber Dam Clamp Fig. 7

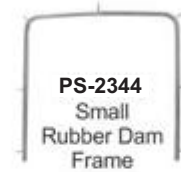

PS-2344
Small
Rubber Dam
Frame

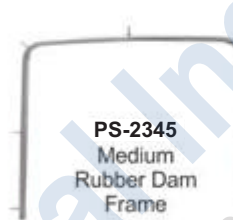

PS-2345
Medium
Rubber Dam
Frame

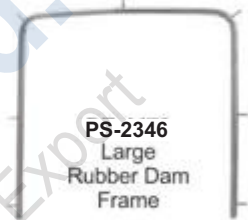

PS-2346
Large
Rubber Dam
Frame



PS-2347
Brewer



PS-2348
Stockes



PS-2349
Palmer



PS-2350
Ivory light weight



PS-2351
Anisworth



PS-2352
Anisworth

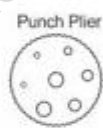

Punch Plier



PS-2353
Anisworth



PS-2354
Ivory



PS-2355
Separating
Elastic Plier

RUBBER DAM CLAMPS KITS



- Резиновая дамба зажимы комплекты
- Trousses de caoutchouc
- Gummidammklammern
- Гумова дамба затискачі комплекти
- Conjuntos de abrazaderas de retención de caucho
- المطاط السد المشابك مجموعات

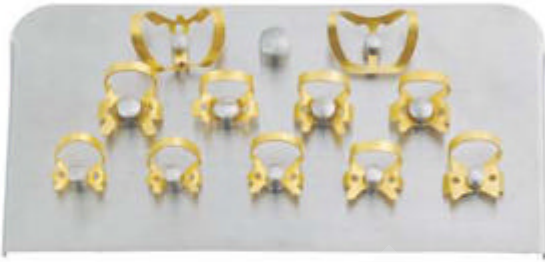

PS-2356

Stainless Steel Gold Plated Rubber Dam Clamp Tray with 11 Different Clamps
Fig. 212, 211, 8, 8A, 14, 14A, 0, 00, 2, 2A, 7



PS-2357

Stainless Steel Rubber Dam Clamp Tray with 12 Different Clamps
Fig. 209, 212, 211, 8, 8A, 14, 14A, 0, 00, 2, 2A, 7



PS-2358

Stainless Steel Rubber Dam Clamp Tray with 8 Different Clamps
Fig. 1, 26, 29, 51, 60, 202, 205, 210



PS-2359

Stainless Steel Rubber Dam Clamp Tray
(without clamps)



PS-2360

On request the Content of the rubber dam kit can be changed with other instruments.

Content:

- | | |
|------------------------------|------------------------------|
| 01 Ivory | 08 Rubber Dam Clamp Fig. 209 |
| 02 Ivory light weight | 09 Rubber Dam Clamp Fig. 212 |
| 03 Clamps Stand | 10 Rubber Dam Clamp Fig. 211 |
| 04 Rubber Dam Frame M | 11 Rubber Dam Clamp Fig. 8 |
| 05 Rubber Dam Frame L | 12 Rubber Dam Clamp Fig. 8A |
| 06 Rubber Dam Box Lower Case | 13 Rubber Dam Clamp Fig. 14 |
| 07 Rubber Dam Box Upper Case | 14 Rubber Dam Clamp Fig. 14A |
| | 15 Rubber Dam Clamp Fig. 0 |
| | 16 Rubber Dam Clamp Fig. 00 |
| | 17 Rubber Dam Clamp Fig. 2 |
| | 18 Rubber Dam Clamp Fig. 2A |
| | 19 Rubber Dam Clamp Fig. 7 |

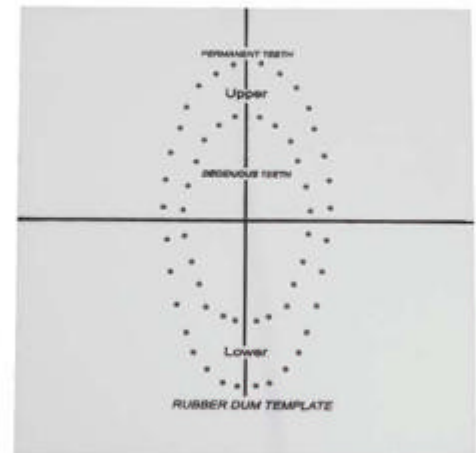

PS-2361

Rubber Dum Template

RUBBER DAM CLAMPS

- Кляммера для коффердама
- Crampons pour digue
- Kofferdam Klammern
- Кляммера для коффердама
- Grapas para dique de caucho
- المشابك السد المطاط



PS-2362
Fig. 15



PS-2363
Fig. 18



PS-2364
Fig. 24



PS-2365
Fig. 25



PS-2366
Fig. 26



PS-2367
Fig. 28



PS-2368
Fig. 30



PS-2369
Fig. 31



PS-2370
Fig. 51



PS-2371
Fig. 138



PS-2372
Fig. 139



PS-2373
Fig. 200



PS-2374
Fig. 201



PS-2375
Fig. 202



PS-2376
Fig. 203



PS-2377
Fig. 204



PS-2378
Fig. 205



PS-2379
Fig. 3



PS-2380
Fig. W3



PS-2381
Fig. 4



PS-2382
Fig. 56A



PS-2383
Fig. 7



PS-2384
Fig. 7A



PS-2385
Fig. 8



PS-2386
Fig. 8A



PS-2387
Fig. W8A



PS-2388
Fig. 10



PS-2389
Fig. 11



PS-2390
Fig. 12A



PS-2391
Fig. 13A



PS-2392
Fig. 14



PS-2393
Fig. 14A



PS-2394
Fig. 14AN



PS-2395
Fig. 22



PS-2396
Fig. 27



PS-2397
Fig. 207



PS-2398
Fig. 29



PS-2399
Fig. 206



PS-2400
Fig. 208



PS-2401
Fig. 209



PS-2402
Fig. 1



PS-2403
Fig. 1A



PS-2404
Fig. 2



PS-2405
Fig. 2A



PS-2406
Fig. W2A



PS-2407
Fig. 0



PS-2408
Fig. 00



PS-2409
Fig. 210



PS-2410
Fig. 211



PS-2411
Fig. 212



PS-2412
Fig. 6



PS-2413
Fig. 9



PS-2414
Fig. N06



PS-2415
Fig. U67



PS-2416
Fig. 214



PS-2417
Fig. P1



PS-2418
Fig. P2



PS-2419
Fig. G-1



PS-2420
Fig. G-2

CROWN REMOVER

- Инструменты для удаления коронок
 - Arrache-couronnes
 - Teleskopkronenzangen
- Инструменты для видалення коронок
 - Arranca-corona
 - مزيلات التاج



PS-2421
Crown Spreaders



PS-2421
Universal
Fig. 0



Manual Crown Removers
Handle with 3 tips DE-1551
Only 3 tips PS-2422 to PS-2424



PS-2422 PS-2423



PS-2424



Manual Crown Removers
Handle with 3 tips DE-1555
Only 3 tips PS-2425 to PS-2427



PS-2425 PS-2426



PS-2427



PS-2428
Manual Crown
Remover



PS-2429
Manual Crown Remover



PS-2430
Complete with 3 tips
and tightening keys

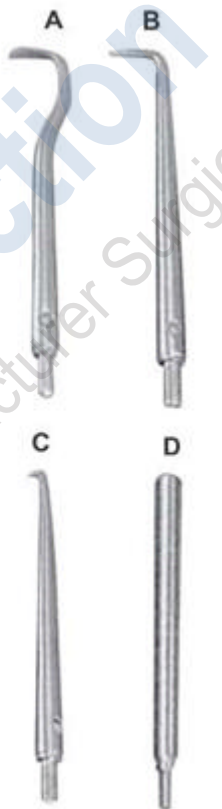

semi-automatic crown
& bridge remover



PS-2431



A B

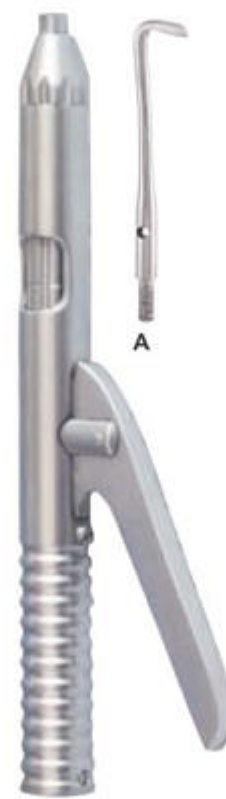

PS-2432
Manual Crown Remover



A B C



D E

MATRIX RETAINERS

- Матрицедержатели
- Porte Matrices
- Matrizenspanner
- Матрицеутримувачи
- Porta Matrices
- مصفوفة الخدم



PS-2433
Fig. 5
Ivory 8
5 cm



PS-2432
Fig. 6
Ivory 8
6 cm



PS-2433
Fig. 7
Ivory 8
7 cm



PS-2434
Fig. 1
Tofflemire-Universal



PS-2435



PS-2436



PS-2437

Siqveland Retainers



PS-2438
Fig. 2
Tofflemire-Junier



PS-2439
Fig. 3
Tofflemire-Senior



PS-2440
Narrow



PS-2441
Wide

Amalgam Well



PS-2442
Stainless Steel
Amalgam Well



PS-2443
Ivory 12



PS-2444
Ivory 1



PS-2445
Ivory



PS-2446
Elliot

AMALGAM INSTRUMENTS



- Инструменты для амальгамы
- Instruments pour amalgame
- Amalgamis/Instrumente
- Инструменти для амальгами
- Instrumentos para amalgama
- الصكوك الملغم



PS-2447
Fig. 10
165mm
English pattern



PS-2448
Fig. 1
185mm
German pattern



PS-2449
Fig. 1
150mm
Swiss pattern



PS-2450
Fig. 1
150mm



PS-2451
Fig. 2
150mm, 45°



PS-2452
Fig. 3
140mm, 90°



PS-2453
Chip Blower



PS-2454



PS-2455



PS-2456



PS-2457
Water Syringe

AMALGAM INSTRUMENTS

- Инструменты для амальгамы
- Instruments pour amalgame
- Amalgamis/instrumente
- Инструменты для амальгами
- Instrumentos para amalgama
- الصوك الملقم

AMALGAM CARRIERS

TIP SIZES FOR DISTAL OR SINGLE-END

1.5 mm



PS-2459
Mini/
Single-End

2.0 mm



PS-2460
Regular
Single-End

2.8 mm



PS-2461
Large
Single-End

1.5 mm



PS-2462
Mini
Distal

2.0 mm



PS-2463
Regular
Distal

TIP SIZES FOR DOUBLE-END

1.5 mm



2.0 mm
PS-2464
Mini/
Regular

2.8 mm



2.0 mm
PS-2465
Large/
Regular

3.2 mm



2.0 mm
PS-2466
Jumbo/
Regular



PS-2458
Single-End



PS-2467
Amalgam
Well

TIP SIZES FOR DOUBLE-END

PS-2468 - 1.5mm-2.0mm
PS-2469 - 2.0mm-2.8mm
PS-2470 - 2.0mm-3.2mm

PS-2471 - 1.0mm-2mm
PS-2472 - 2.0mm-3mm
PS-2473 - 2.0mm-4mm

PS-2474 - 1.5mm-2.0mm
PS-2475 - 2.0mm-2.8mm
PS-2476 - 2.0mm-3.2mm

PS-2477 - 1.0mm-2mm
PS-2478 - 2.0mm-3mm
PS-2479 - 2.0mm-4mm

PS-2480 - 1.5mm-2.0mm
PS-2481 - 2.0mm-2.8mm
PS-2482 - 2.0mm-3.2mm

PS-2483 - 1.0mm-2mm
PS-2484 - 2.0mm-3mm
PS-2485 - 2.0mm-4mm

PS-2486 - 1.5mm-2.0mm
PS-2487 - 2.0mm-2.8mm
PS-2488 - 2.0mm-3.2mm

PS-2489 - 1.0mm-2mm
PS-2490 - 2.0mm-3mm
PS-2491 - 2.0mm-4mm

PS-2491 - 1.5mm
PS-2493 - 2.0mm
PS-2494 - 2.0mm
PS-2495 - 3.0mm

CHISELES, BONE FILES & SPOONE CURETTE



PS-2496

PS-2497

PS-2498

PS-2499



PS-2500
4mm
(Straight)



PS-2501
4mm
(Curved)



PS-2502
6mm
(Straight)



PS-2503
6mm
(Curved)

Periodontal Chisels



PS-2504



PS-2505



PS-2506



PS-2507

ROOT PLANNING FILES



PS-2508
Kramer-Nevins
Bone Chisel



PS-2509
Kramer-Nevins
Bone Chisel



PS-2510
Molt 18.5cm
Auto Clavable
Plastic Tips.

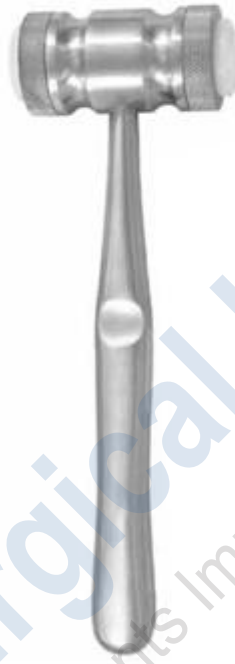

PS-2511
Mead 18.5cm
Non Auto Clavable
Plastic Tips.



PS-2512
Miller



PS-2513
Miller

BONE FILES



PS-2514
Miller 21



PS-2515
Miller 1X
cross cut



PS-2516
Miller 2X
cross cut



PS-2517
Miller 52



PS-2518
Wahl 1

PERIODONTAL INSTRUMENTS



- Инструменты пародонтологические
- Instruments pour la parodontologie
- Instrumente für die parodontologie
- Інструменти пародонтологічні
- Instrumentos para periodoncía
- الصكوك اللثة

PERIOSTEEL ELEVATORS



PS-2519
Ohi 10



PS-2520
Howard 9H



PS-2521
Freer



PS-2522
Freer 15



PS-2523
Freer 16



PS-2524



PS-2525
Raspator, Raspatory
Length 175 mm



PS-2526



PS-2527



PS-2528



DE-1662

Raspator, Williger
Length 170 mm, different widths
(4 mm, 5 mm or 7 mm)



Partsch 140 mm
PS-2530 3mm
PS-2531 4mm
PS-2532 5mm
PS-2533 6mm



Partsch 170 mm
PS-2534 3mm
PS-2535 4mm
PS-2536 5mm
PS-2537 6mm



Partsch 140 mm
PS-2538 3mm
PS-2539 4mm
PS-2540 5mm
PS-2541 6mm



Partsch 170 mm
PS-2542 3mm
PS-2543 4mm
PS-2544 5mm
PS-2545 6mm

PERIODONTAL INSTRUMENTS

- Инструменты пародонтологические
- Instruments pour la parodontologie
- Instrumente für die Parodontologie
- Інструменти пародонтологічні
- Instrumentos para periodoncia
- الصكوك اللثة

To separate tissue tooth or bone. tp hold tissue away from surgical site.

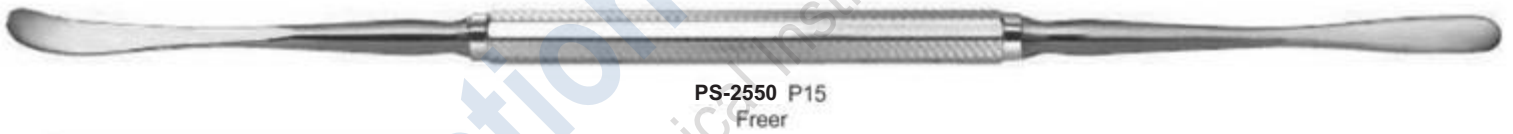
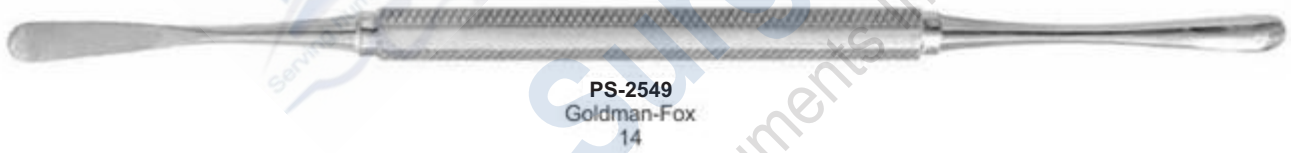
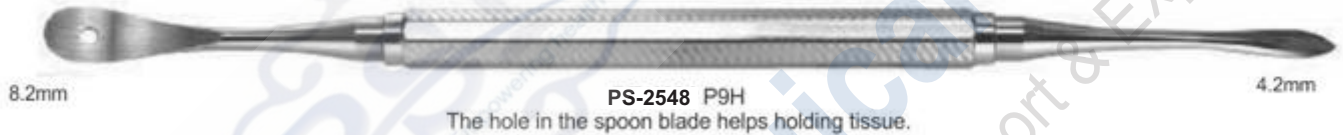

PERIODONTAL INSTRUMENTS



- Инструменты пародонтологические
- Instruments pour la parodontologie
- Instrumente für die Parodontologie
- Інструменти пародонтологічні
- Instrumentos para periodoncia
- الصكوك اللثة



PS-2556



PS-2557
P24G



PS-2558
titanium Periosteal Elevator for Implan5



PS-2559
S1



PS-2560
Hirschfeld

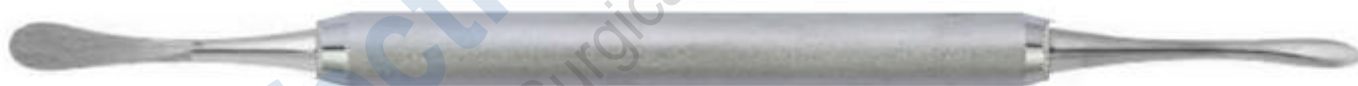

PS-2561
9S



10mm

PS-2562
Selden

13mm

4.8 mm

Prichard

10.6 mm

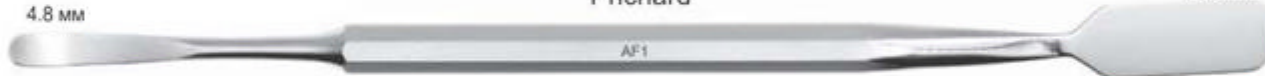

PS-2563
Friedmann



6.9 mm

PS-2564
Schmidlin

SCALPEL HANDLES

- Ручки для скальпелей
- Manches de bistouris
- Skalpellgriffe
- Ручки для скальпелів
- Mangos de bisturi
- مشروط مقابض



PS-2565
Fig.3
12.7cm



PS-2566
Fig.3G
12.7cm



PS-2567
Fig.4
13.7cm



PS-2568
Double Handle
No.4 + No.3
16.3cm



PS-2569
Fig. 7
16.5cm



PS-2570
Scalpel Handle Straight
for blades #10-15
14.5cm



PS-2571
Micro Surgical Scalpel
Handle titanium
13.5cm



PS-2572
Fig. 5
14.5cm



PS-2573
Fig. 5A
14.5cm



PS-2574
6 Way Adjustable Angled
Scalpel Handle

MALLETS - PLASTER SHEARS - SAWS & BLADES



PS-2575
Metal tip
220 mm
Hammer With Wooden Handle



PS-2576
Metal tip
220 mm



PS-2577
1
For plaster



PS-2578
2
For metal



PS-2579
Fret saw
250 mm



PS-2580
Small
Saw Blades



PS-2581
Large
Saw Blades



PS-2582
Ceri Saw



Special Inox
PS-2583 170mm
PS-2584 200mm



PS-2585
Plaster Shears
200 mm



Crucible Tongs
PS-2586 250 mm
PS-2587 320 mm



PS-2588
Ceri Saw
180 mm



PS-2589
Blade
0,12x5 mm
Conf. 12 pcs



PS-2590
Blade
0,25x5 mm
Conf. 12 pcs



PS-2591
Blade
0,25x3 mm
Conf. 12 pcs



Behind Every Smile is a Story

- QUALITY - ЯКІСТЬ
- PRECISION - ТОЧНІСТЬ
- ACCURACY - ПРАВИЛЬНІСТЬ
- DURABILITY - ЗНОСОСТІЙКІСТЬ



STYLE A

- Super-sharp diamond bevel cutters
- smooth ultra polished and rounded edges
- brilliant corrosion resistant stainless steel finish
- superior T12 stainless steel tool inserts
- sliding lock joint for balance & precision alignment

STYLE B

- Super-sharp diamond bevel cutters
- smooth ultra polished and rounded edges
- brilliant corrosion resistant stainless steel finish
- superior T12 stainless steel tool inserts
- sliding lock joint for balance & precision alignment

ORTHODONTIC INSTRUMENTS



- Инструменты ортодонтические
- Instrumentos Ortodonticos
- Orthodontische Instrumente
- Инструменти ортодонтични
- Instruments Orthodontiques
- أدوات تقويم الأسنان



PS-2592
Height Gauge 0.18
Aluminum



PS-2593
Height Gauge 0.22
Aluminum



PS-2594
Height Gauge 0.18
Stainless Steel



PS-2595
Height Gauge 0.22
Stainless Steel



PS-2596
Moveable
Height Gauge



PS-2597
Endo Finger
Ruler Span
Measure Scale



PS-2598
Endo Finger
Ruler Span
Measure Scale



PS-2599
Endo Finger
Ruler Span
Measure Scale



PS-2601
Positive
Postioner



PS-2602
Strip Saw



PS-2603
Bone Bracket Gauge



PS-2600
Endo Finger Ruler
Span Measure Scale



PS-2604
Endo Finger Ruler
Span Measure Scale

ORTHODONTIC INSTRUMENTS

- Инструменты ортодонтические
- Instrumentos Ortodonticos
- Orthodontische Instrumente
- Инструменти ортодонтични
- Instruments Orthodontiques
- أدوات تقويم الأسنان



PS-2605
Measuring Loop
angled, length
175 mm,
measuring range
0 - 40 mm



PS-2606
Measuring Loop
straight length
175 mm,
measuring range
0 - 40 mm



PS-2607
Measuring loop, Castroviejo
angled, length 175 mm,
measuring range 0 - 40 mm,
with window



PS-2608
Measuring Loop
straight length 90 mm,
measuring range
0 - 40 mm,

PS-2609
Castroviejo Calipers
20mm
90mm



PS-2610
Measuring Loop
angled, length 90 mm,
measuring range
0 - 40 mm,

PS-2611
Castroviejo Calipers
20mm, 45°
90mm



PS-2612
Castroviejo Calipers
20mm
90mm



PS-2613
Fig. 1
Iwanson
spring caliper
For metal and
porcelain.



PS-2614
Fig. 2
Iwanson
spring caliper
For wax.

ORTHODONTIC INSTRUMENTS



- Инструменты ортодонтические
 - Instrumentos Ortodonticos
 - Orthodontische Instrumente
- Инструменти ортодонтични
 - Instruments Orthodontiques
 - أدوات تقويم الأسنان



PS-2615
Boley Gauge



PS-2616
Vernier Gauge



PS-2617
Aluminium Caliper
up to 200mm



PS-2618
Boley Gauge

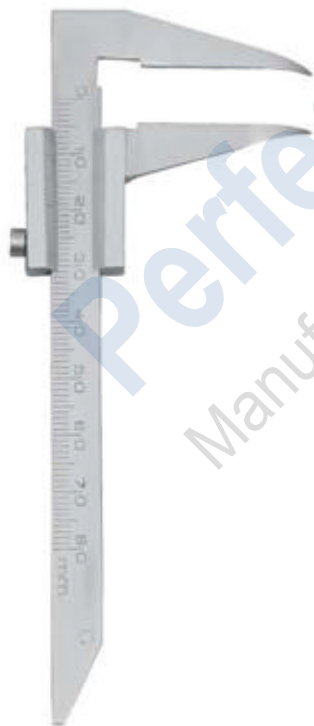

PS-2619
Delux Boley
Gauge



PS-2620
Beerendonk
130mm
Mini Gauge



PS-2621
Compasso
De Willis



PS-2622
Dentaurum
Ruler



PS-2623
Ruler Wedge



PS-2624
Ruler

ORTHODONTIC INSTRUMENTS

- Инструменты ортодонтические
- Instrumentos Ortodonticos
- Orthodontische Instrumente
- Инструменти ортодонтични
- Instruments Orthodontiques
- أدوات تقويم الأسنان

Bracket Holder Tweezers



PS-2625
Deluxe Bracket
Holder Tweezers



PS-2626
Deluxe Bracket
Holder Tweezers



PS-2627
Direct Bond Bracket
Holder Tweezers



PS-2628
Bracket Tweezers
Slot Aligner



PS-2629
Direct Bond
Bracket Holder
Tweezers, Small Tip



PS-2630
Exact Bracket
Holder Tweezers



PS-2631
Bracket Placing
Tweezers



PS-2632
Easy Access
Tweezers



PS-2633
Bracket Placer
Tweezers
(Extra Fine Tip)



PS-2634
Deluxe Bracket
Holder Tweezers
135mm



PS-2635
Easy Access
Tweezers



PS-2636
Slipper
Tweezers



PS-2637
Direct Bonding
Bracket Holders
135mm



PS-2638
Direct Bonding
Bracket Holders
136mm



PS-2639
Direct Bonding
Bracket Holders
135mm



PS-2640
Deluxe Bracket
Holder



PS-2641
Direct Bonding
Bracket Holders
140mm

ORTHODONTIC INSTRUMENTS



- Инструменты ортодонтические
 - Instrumentos Ortodonticos
 - Orthodontische Instrumente
- Инструменти ортодонтични
 - Instruments Orthodontiques
 - أدوات تقويم الأسنان



PS-2642
Band seater
auto cleavable



PS-2643
Band seater
auto cleavable
Triangle Shape



PS-2644
Band seater
auto cleavable
Square Shape



PS-2645
Band seater
auto cleavable
Round Shape



PS-2646
Mershon Band
Pusher
140mm



PS-2647
Band seating &
removing
instruments



PS-2648
Ortho Light double
ended
ligature director
scaler



PS-2649
Ortho Light Band
Pusher Scaler



PS-2650
Band Seating &
Removing
Silicon Grip



PS-2651
Ligature Instrument
Silicon Grip



PS-2652
Elastic Instrument
Silicon Grip



PS-2653
Distal Bender
Silicon Grip



PS-2654
Distal Bender
Silicon Grip



PS-2655
Distal Bender
Silicon Grip

ORTHODONTIC INSTRUMENTS

- Инструменты ортодонтические
- Instrumentos Ortodonticos
- Orthodontische Instrumente
- Инструменти ортодонтични
- Instruments Orthodontiques
- أدوات تقويم الأسنان



PS-2656
Ortho light scaler double ended



PS-2657
Ortho light scaler double ended



PS-2658
Ortho light scaler double ended



PS-2659
Twiel-on elastic module instrument



PS-2660
Twiel-on elastic module instrument



PS-2661
Schure Band Seater



PS-2662
Ortho light scaler



PS-2663
Ortho light scaler



PS-2664
Ortho light scaler heavy



PS-2665
Ortho instrument



PS-2666
Ortho instrument

ORTHODONTIC INSTRUMENTS



- Инструменты ортодонтические
- Instrumentos Ortodonticos
- Orthodontische Instrumente
- Инструменти ортодонтични
- Instruments Orthodontiques
- أدوات تقويم الأسنان



PS-2667
Ortho Light double ended
ligature director



PS-2668
Ortho Light double ended ligature scaler director tivate coil spring
are remove modules with one instruments



PS-2669
Ortho band pusher scaler



PS-2670
Ortho ligature director single ended



PS-2670
Ortho Light double ended ligature
director scaler



PS-2671
Ortho Light double ended ligature scaler/director
tivate coil spring are remove modules with one instruments



PS-2672
Ortho Light double ended ligature director



PS-2673
Ortholite Ligature Director Scaler



PS-2674
Ortho light ligature director double ended



PS-2675
Double ended cement spatula



PS-2676
Ortho light scaler single ended

PLIERS FOR ORTHODONTICS & PROSTHETICS

- Щипцы для ортодонтии и протезирования
- Pincers pour l'orthodontie et la prothèse
- Zangen für Kieferorthopädie und Prothetik
- Щипці для ортодонції та протезування
- Alicates para ortodoncia y prótesis
- كمانشة لتقويم الأسنان برومبشيس

BOX JOINT PLIERS

PS-2677
Universal Dolphin Style
Wire Bending & cutting pliers



PS-2683
Bracket Removing Plier curved
Bracket Removing Plier curved for
easy removal of brackets in the
posterior region. Length 130mm



PS-2678 Band Removing Plier
The curved blade of the band
removing plier can strip easily
and gently remove directly to
the tooth. Length 130mm



PS-2684
Young Wire Bending &
Loop Forming Pliers



PS-2679
Tweed Loop
forming Pliers



PS-2685
Wire Bending &
Loop Forming Pliers



PS-2680
How Plier curved
Universally usable tool for
the multiband technology for
wires up to .028". Length 130mm



PS-2686
Adams, small wire bending
and loop forming Pliers



PS-2681 How Plier
Universally usable tool for the
multiband technology for wires
up to .028". Length 135mm



PS-2687
Bracket Removing Plier Round Box
Bracket removing plier for comfortable
and quick removal of the brackets.
Length 135mm



PS-2682
Nance Loop
forming Pliers



PS-2688
Weingart Plier medium
Weingart plier that are ideal due to
their curved tip for setting sheets and
is capable of bending the ends.
Length 145mm



PLIERS FOR ORTHODONTICS & PROSTHETICS



- Щипцы для ортодонтии и протезирования
- Пинцес pour l'orthodontie et la prothèse
- Zangen für Kieferorthopädie und Prothetik
- Щипці для ортодонції та протезування
- Alicates para ortodoncia y prótesis
- كمشاة لتقويم الأسنان بروستتیس

BOX JOINT PLIERS

PS-2689 Adams Plier Round Box
Adams pliers for bending wire arches and bends right angles for wires up to .022", .025 tip to beak. Length 125mm



PS-2695 Adams Plier
Adams pliers for bending wire arches and bends right angles for wires up to .022", .025 tip to beak. Length 125mm



PS-2690 Falcon Beak Contouring Pliers.



PS-2696 Tweed Loop Formin Pliers



PS-2691
wires up to 0.020" / 0.7mm.



PS-2697 Bird Beak Plier Standard
Bird Beak Wire bending plier without notches, which is suitable as a universal utility tool. Length 125mm



PS-2692 Johnson Contouring Pliers



PS-2698 Mini Ligature cutters



PS-2693 Aderer Large wire bending and loop forming pliers



PS-2699 Small Fluch-cut distal and cutting Pliers with safety hold fitted with un-breakable, corrosion resistant and durable stainless steel tips



PS-2694 Tweed / angle rectangular arch forming & Torquing pliers



PS-2700 Large Fluch-cut distal and cutting Pliers with safety hold fitted with un-breakable, corrosion resistant and durable stainless steel tips



PLIERS FOR ORTHODONTICS & PROSTHETICS

- Щипцы для ортодонтии и протезирования
- Pincers pour l'orthodontie et la prothèse
- Zangen für Kieferorthopädie und Prothetik
- Щипці для ортодонції та протезування
- Alicates para ortodoncia y prótesis
- كمانشة لتقويم الأسنان برومستیس

BOX JOINT PLIERS

PS-2701

Tweed / Angel

1.78mm (.070") wide tips arch forming and torquing pliers



PS-2707

Contouring Plier



PS-2702

Tweed / Angel

1.78mm (.070") wide tips arch forming and torquing pliers



PS-2708

Bands & Crowns Plier
in order to skirt



PS-2703

Lingual / Palatal arch forming pliers



PS-2709

Ligature Forming Pliers



PS-2704

Aderer

Facebow loop forming Pliers



PS-2710

for double back and triple back bands in 0.30" / 0.76mm & 0.36" / 0.91mm lingual arch wires



PS-2705

Waldsavhs wire bending and cutting pliers



PS-2711

Bird Beak Wire Bending & cutting pliers



PS-2706 Aderer Plier

For the manufacturing of appliances and activation of wires for wires up to .030" .fine tip and up to .036" mean tip. Length 130mm



PS-2712

Weingart Plier medium

Weingart plier that are ideal due to their curved tip for setting sheets and is capable of bending the ends. Length 145mm

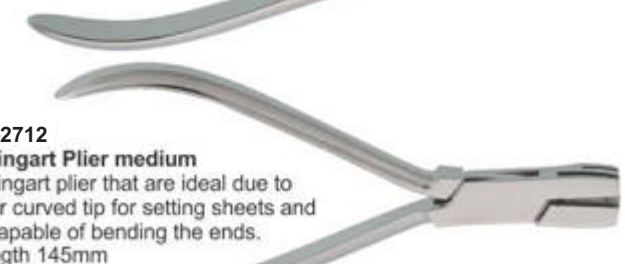

PLIERS FOR ORTHODONTICS & PROSTHETICS



- Щипцы для ортодонтии и протезирования
- Пинцес pour l'orthodontie et la prothèse
- Zangen für Kieferorthopädie und Prothetik
- Щипці для ортодонції та протезування
- Alicates para ortodoncia y prótesis
- كمشة لتقويم الأسنان بروستھتیس

L-KEY JOINT PLIERS



PS-2713
Distal end cutter with safety hold, mini head, long handles, fitted with un-breakable, corrosion resistant and durable stainless steel tips

- 0.30 mm to 0.50 mm (.012" to .020")
- Max. 0.46 mm x 0.64 mm (.018" x .025")
- ⊗ 0.38 mm to 0.53 mm (.0155" to .0215")
- ⊗ Max. 0.53 mm x 0.64 mm (.021" x .025")



PS-2714
Flush-cut distal end cutter with safety hold fitted with un-breakable, corrosion resistant and durable stainless steel tips

- 0.30 mm to 0.50 mm (.012" to .020")
- Max. 0.46 mm x 0.64 mm (.018" to .025")



PS-2715
Soft wire and ligature cutter, Mini fitted with un-breakable, corrosion resistant and durable stainless steel tips

- ⌋ .25 mm to .38 mm (.010" to .015")



PS-2716
Soft wire and ligature cutter, standard fitted with un-breakable, corrosion resistant and durable stainless steel tips

- ⌋ .25 mm to .38 mm (.010" to .015")



PS-2717
Soft wire and ligature cutter, 15° angled fitted with un-breakable, corrosion resistant and durable stainless steel tips

- ⌋ .25 mm to .38 mm (.010" to .015")



PS-2718
Soft wire and ligature cutter, 45° angled fitted with un-breakable, corrosion resistant and durable stainless steel tips

- ⌋ .25 mm to .38 mm (.010" to .015")



PS-2719
Hard wire cutter, straight Fitted with un-breakable, corrosion resistant and durable stainless steel tips

- 0.30 mm to 0.50 mm (.012" to .020")
- Max. 0.56 mm x 0.71 mm (.022" x .028")



PS-2720
Hard wire cutter, 15° angled Fitted with un-breakable, corrosion resistant and durable stainless steel tips

- 0.30 mm to 0.50 mm (.012" to .020")
- Max. 0.56 mm x 0.71 mm (.022" x .028")



PS-2721
Hard wire cutter, 15° angled Non-autoclavable

- 0.30 mm to 0.50 mm (.012" to .020")
- Max. 0.56 mm x 0.71 mm (.022" x .028")

PLIERS FOR ORTHODONTICS & PROSTHETICS

- Щипцы для ортодонтии и протезирования
- Pincers pour l'orthodontie et la prothèse
- Zangen für Kieferorthopädie und Prothetik
- Щипці для ортодонції та протезування
- Alicates para ortodoncia y prótesis
- كمانشة لتقويم الأسنان برومبشيس

L-KEY JOINT PLIERS



PS-2722
Band removing pliers



PS-2723
Bracket removing pliers angled



PS-2724
Bracket removing pliers straight



PS-2725
Bracket removing pliers with plastic tip



PS-2726
Adhesive removing pliers



PS-2727
Weingart-mini
Utility Pliers

- 0.30 mm to 0.50 mm (.012" to .020")
- Max 0.56 mm x 0.71 mm (.022" x .028")



PS-2728
Weingart
Utility Pliers

- 0.30 mm to 0.50 mm (.012" to .020")
- Max 0.56 mm x 0.71 mm (.022" x .028")



PS-2729
How Straight
Utility Pliers

- 0.30 mm to 0.50 mm (.012" to .020")
- Max 0.56 mm x 0.71 mm (.022" x .028")



PS-2730
Angled
Utility Pliers

- 0.30 mm to 0.50 mm (.012" to .020")
- Max 0.56 mm x 0.71 mm (.022" x .028")



PS-2731
Wire bending and loop forming pliers
Angled (Bird beak)

- 0.30 mm to 0.50 mm (.012" to .020")
- Max 0.56 mm x 0.71 mm (.022" x .028")

PLIERS FOR ORTHODONTICS & PROSTHETICS



- Щипцы для ортодонтии и протезирования
- Pincers pour l'orthodontie et la prothèse
- Zangen für Kieferorthopädie und Prothetik
- Щипці для ортодонції та протезування
- Alicates para ortodoncia y prótesis
- كمانشة لتقويم الأسنان بروستھتیس

L-KEY JOINT PLIERS



PS-2732
Multi-purpose pliers, bird beak,
De la rosa and cutter in one

- 0.30 mm to 0.50 mm (.012" to .020")
- Max. 0.46 mm x 0.56 mm (.018" x .022")



PS-2737
Stop pliers V-Bebd - 1mm

- 0.30 mm to 0.50 mm (.012" to .020")
- Max. 0.43 mm x 0.56 mm (.017" x .028")



PS-2733
Cinch Back / tie back
Distal end bending pliers

- 0.30 mm to 0.50 mm (.012" to .020")
- Max. 0.56 mm x 0.71 mm (.022" x .028")



PS-2738
Lingual / palatal arch forming plies

- 0.76 mm (.030") / 0.91 mm (.036")



PS-2734
Hammer head
Distal end bending pliers

- 0.30 mm to 0.50 mm (.012" to .020")
- Max. 0.56 mm x 0.71 mm (.022" x .028")

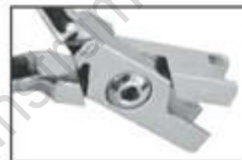

PS-2739
Torquing pliers set



PS-2735
Nance
Loop forming pliers

- 0.36 mm to 0.71 mm (.014" to .028")
- Max. 0.56 mm x 0.71 mm (.022" x .028")



PS-2740
Tweed / angel
Rectangular arch forming and
torquing pliers

- 0.30 mm to 0.71 mm (.012" to .028")
- Max. 0.56 mm x 0.71 mm (.022" x .028")



PS-2736
Detailing step pliers / Bayonet
bending pliers - 1mm

- 0.30 mm to 0.50 mm (.012" to .020")
- Max. 0.56 mm x 0.71 mm (.022" x .028")



PS-2741
Surgical ball hook crimping pliers,
angled



PS-2742
Surgical ball hook crimping
pliers, straight



PLIERS FOR ORTHODONTICS & PROSTHETICS

- Щипцы для ортодонтии и протезирования
- Pincettes pour l'orthodontie et la prothèse
- Zangen für Kieferorthopädie und Prothetik
- Щипці для ортодонції та протезування
- Alicates para ortodoncia y prótesis
- كمانشة لتقويم الأسنان برومبشيس

L-KEY JOINT PLIERS



PS-2743
Aderer Clamp three jaw wire bending plier for contouring and bending wire up to .30"/.76mm.



PS-2749
Falcon beak contouring plier.

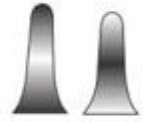

PS-2744
Bird beak plier for bending round, square and rectangle wire up to .30"/.76mm.

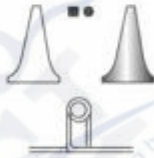

PS-2750
For placement and removal of arch wires, pins and other auxiliaries.



PS-2745
Bird beak plier for light wire bending round, square and rectangular up to .016"/0.41mm.



PS-2751
For placement and removal of arch wires, pins and other auxiliaries in angle design



PS-2746
Double Rounded jaw bending pliers, hooks and wire up to .020"/0.51mm.

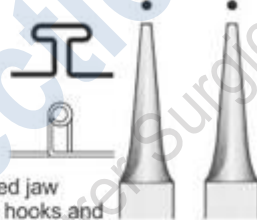

PS-2752
contouring Plier.



PS-2753
Bending plier. In order to skirt molares bands. With grooved. Recommended wire. 016", 018" and 022" 0.41mm, 0.46mm and 0.56mm



PS-2747
Adams pliers for hooks and bending wire up to .030"/0.76mm.



PS-2754
Loop forming in four length 3,4,5 & 6 mm wire capacity 0.22" / 0.56mm.



PS-2748
Johnson pliers for crown band contouring



PS-2755
Arch bending plier design for convenient handling of square or rectangular wire, .020" / 0.51mm.



PLIERS FOR ORTHODONTICS & PROSTHETICS



- Щипцы для ортодонтии и протезирования
- Пинсы pour l'orthodontie et la prothèse
- Zangen für Kieferorthopädie und Prothetik
- Щипці для ортодонції та протезування
- Alicates para ortodoncia y prótesis
- كمامة لتقويم الأسنان بروستتیس

LAP & L-KEY JOINT PLIERS



PS-2756
In order to skirt bands and crowns.



PS-2757
Wires up to .020" / 0.7mm.

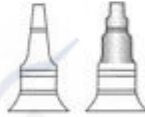

PS-2758
Round and concave plier for loop forming and banding wire up to .20" / .051mm.



PS-2759
Bending for round square or rectangular wire up to 0.30"/0.76mm



PS-2760
for double back and triple back bands in 0.30" / .76mm & 0.36" / .91mm lingual arch wires.



PS-2761
Detailing step plier double-sided offset beak permits bayonet bends. Creates right hand or left hand step-up or stepdown at 1/2, 3/4, or 1mm increments.

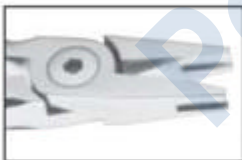

PS-2762
"V" bend stop special design makes 1mm "v" bends to shorten archwires or provide a positive stop. Excellent for placing stops in titanium wires. For round or rectangular wires up to .025"



PS-2763
Angle how plier efficient utility plier with serrated beaks for a firm grip. 45 angled tips to access hard to reach areas.



PS-2764
Weingardt plier serrated tips hold wires firmly at a convenient working angle. Tapered beaks fit easily between brackets and hard to reach areas. Our most popular utility plier.



PS-2765
Pin & Ligature Cutters TC.



PS-2766
Mini Pin & Ligature Cutter TC.



PS-2767
Standard Ligature Cutter TC.



PS-2768
V Bend Stop Plier TC.



PS-2769
Angled Direct Bond Bracket Remover TC.



PS-2770
Cutter Str.



Distal Cutter 14cm
PS-2771 2.5 mm
PS-2772 3.0 mm
PS-2773 3.0 mm



PS-2774
Arrow Clasp Forming Pliers 12.0cm



PS-2775
Schwarz 12.5cm



PS-2776
Distal end Cutter, Safety Hold Plier
(Ideal for Cutting Wire) TC.



PS-2777
Hook Crimping Plier Angled
Straight TC.



PS-2778
3 Prong Clasp Adjustable
Plier TC.



PS-2779
Utility Plier Weingart TC.



PS-2780
Direct Bracket Remover
TC.



PS-2781
Straight Direct Bond Bracket
Remover TC.



PS-2782
Pin Holding Plier TC.



PS-2783
Hard wire cutters



PS-2784
Elastic Separating Plier
Round Handle

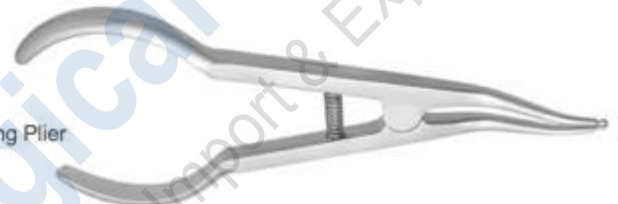

PS-2785
Elastic
Separating Plier



PS-2786 Str.
PS-2787 Cvd.
Smaha
Elastomeric
ligature
placing forceps
140 mm



PS-2788
Elastomeric
ligature
placing
forceps with
groove
Falcon 140 mm



PS-2789
Elastomeric
ligature
placing
forceps with
groove
Falcon 140 mm



PLIERS FOR ORTHODONTICS & PROSTHETICS



- Щипцы для ортодонтии и протезирования
- Pincas pour l'orthodontie et la prothèse
- Zangen für Kieferorthopädie und Prothetik
- Щипці для ортодонції та протезування
- Alicates para ortodoncia y prótesis
- كمانة لتقويم الأسنان بروسشیتس

CUTTER, UTILITY PLIERS & WIRE FORMING PLIERS



PS-2790
Weingart Pliers



PS-2795
Adhesive
Removing Pliers



PS-2791
Slim Weingart
Pliers



PS-2796
Posterior Band Removing
Pliers - Long



PS-2792
How Pliers
Straight



PS-2797
Posterior Band Removing
Pliers - Short



PS-2793
How Pliers Offset

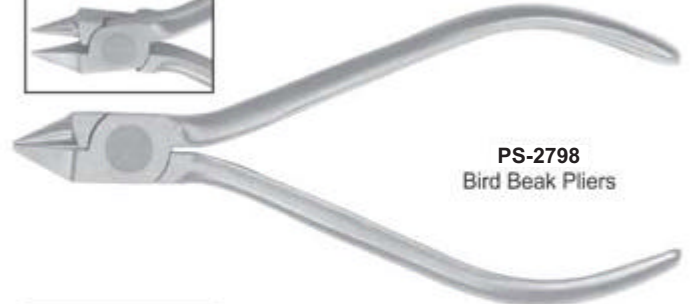

PS-2798
Bird Beak Pliers



PS-2794
Band seating Pliers

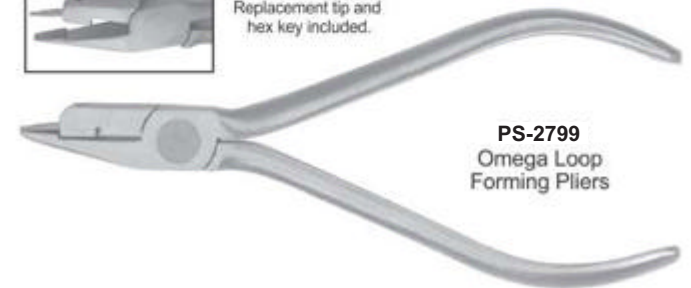

Replacement tip and
hex key included.

PS-2799
Omega Loop
Forming Pliers

- Щипцы для ортодонтии и протезирования
- Pincers pour l'orthodontie et la prothèse
- Zangen für Kieferorthopädie und Prothetik
- Щипці для ортодонції та протезування
- Alicates para ortodoncia y prótesis
- كمانشة لتقويم الأسنان برومبشيس

CUTTERS



PS-2800
Hard
Wire Cutter 15



PS-2804
Mini Pin &
Ligature Cutter



PS-2801
Distal End Cutter
Flush Cut



PS-2805
Hard Wire Cutter
Straight



PS-2802
Universal Cut & Hold
Distal End Cutter



PS-2806
Micro-Mini Pin &
Ligature Cutter



PS-2803
Pin & Ligature
Cutter



PS-2807
Cutter

PLIERS FOR ORTHODONTICS & PROSTHETICS



- Щипцы для ортодонтии и протезирования
- Pincers pour l'orthodontie et la prothèse
- Zangen für Kieferorthopädie und Prothetik
- Щипці для ортодонції та протезування
- Alicates para ortodoncia y prótesis
- كمشة لتقويم الأسنان بروستھتیس



PS-2808
Three Jaw Pliers



PS-2812
Jarabak Pliers



PS-2809
Light Wore Bird Beak
Pliers with Groove



PS-2813
Hollow Chop
Contouring Pliers



PS-2810
Tweed loop
Forming Pliers

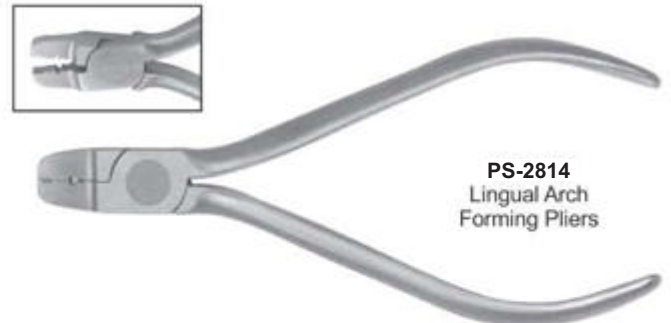

PS-2814
Lingual Arch
Forming Pliers



PS-2811
Arch Bending Pliers

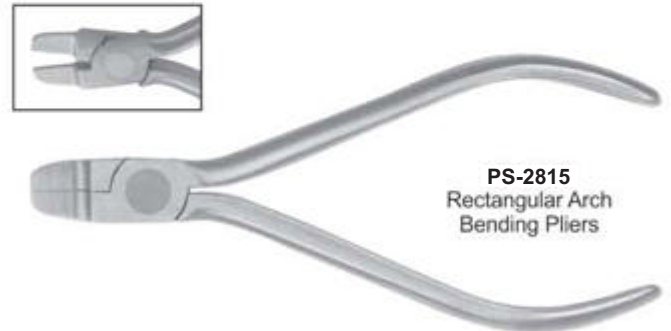

PS-2815
Rectangular Arch
Bending Pliers

ORTHODONTICS PLIERS STANDS

- Ортодонтия Щипцы Подставки
- Supports de pinces d'orthodontie
- Kieferorthopädie Zangenständer
- Ортодонтия Щипці Підставки
- KFO Zangen Ständer
- تقويم الأسنان كعاشة تقف



PS-2816
Plier Stand
Stainless Steel.

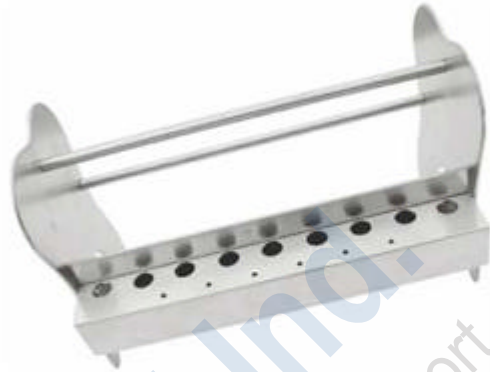

PS-2817
Plier Stand
Stainless Steel.



PS-2818
Pliers Stand
Stainless Rod
(Aluminum Anodized)
Stainless Steel



PS-2819
Plier Stand
Stainless Steel.





PS-2820
Plier Stand
Stainless Steel.



PS-2821
Plier Stand
Plastic

Normal Anatomy – Dental Implants

Bone Level Normal
(No Bone Loss)

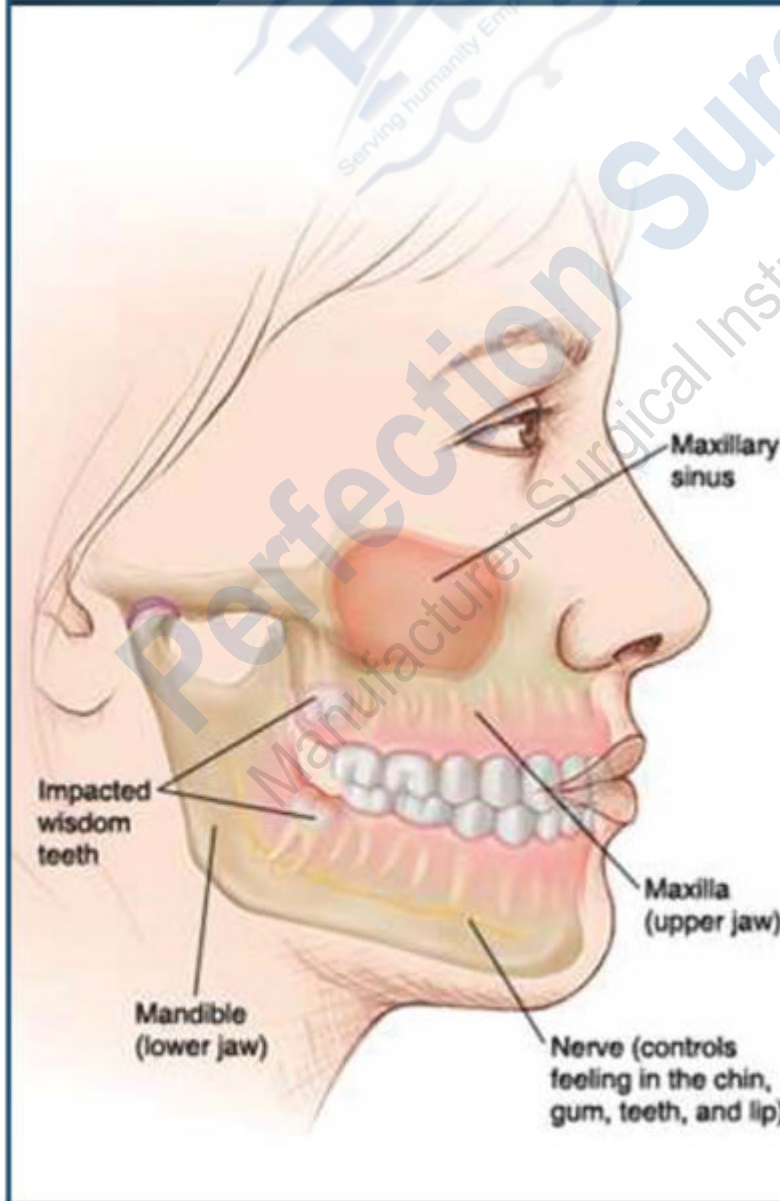
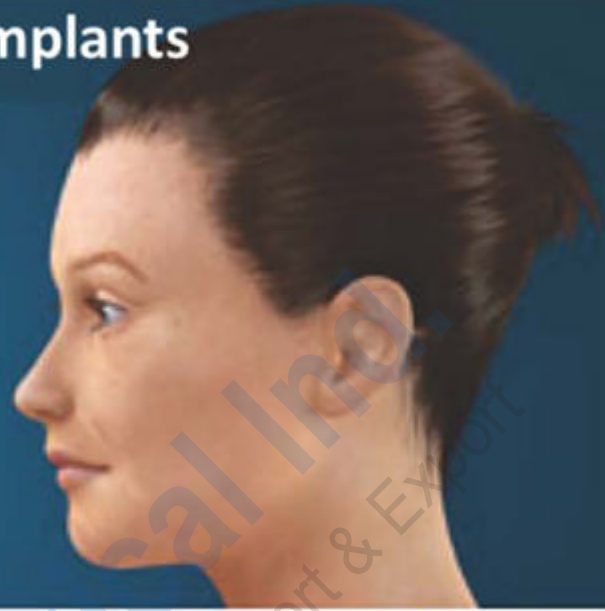
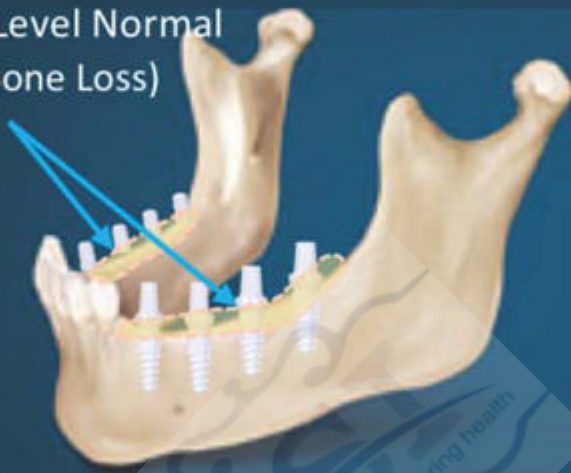

IMPLANTOLOGY

- Инструменты для имплантологии
 - Implantologie
 - Implantologie
- Инструменти для имплантології
 - Implantologia
 - زراعة الأسنان

IMPLANT GAGES



PS-2822
Multifunctional Meter
 Length 90 mm,
 different sizes,
 8-10-11mm,
 corrosion-resistant

PS-2823
Multifunctional Meter
 Length 90 mm,
 different sizes,
 5-13-15-17 mm,
 corrosion-resistant

PS-2824
Measuring Probe
 Length 170 mm,
 hand shape or flexible
 (6-8-10-14-16 mm),
 corrosion-resistant

PS-2825

PS-2826

PS-2827

PS-2828

IMPLANT GAGES



PS-2829

PS-2830

PS-2831

IMPLANTOLOGY



- Инструменты для имплантологии
- Implantologie
- Implantologie

- Инструменти для имплантології
- Implantoloia
- زراعة الأسنان



PS-2832
Ridge Mapping
Double Caliper



PS-2833
Bone Thickness Gauge
40mm, 180mm



PS-2834
Osteometer
Measuring Forceps For Jaw
Ridge Width measurement, scale
on both sides, rustfree, autoclavic



PS-2835
Micro Boley
Gauge Twisted



PS-2836
Micro Boley
Gauge Straight



PS-2837
Ortho Ruler / Cone Socket

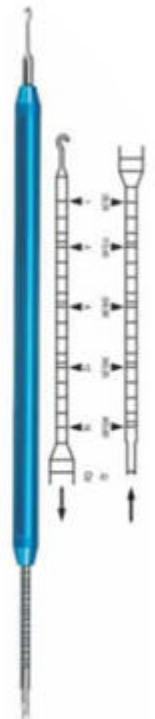

PS-2838
Dynamometer

- Инструменты для имплантологии
 - Implantologie
 - Implantologie
- Инструменти для імплантології
 - Implantologia
 - زراعة الأسنان

BLACK TITANIUM COLOUR COATED INSTRUMENTS

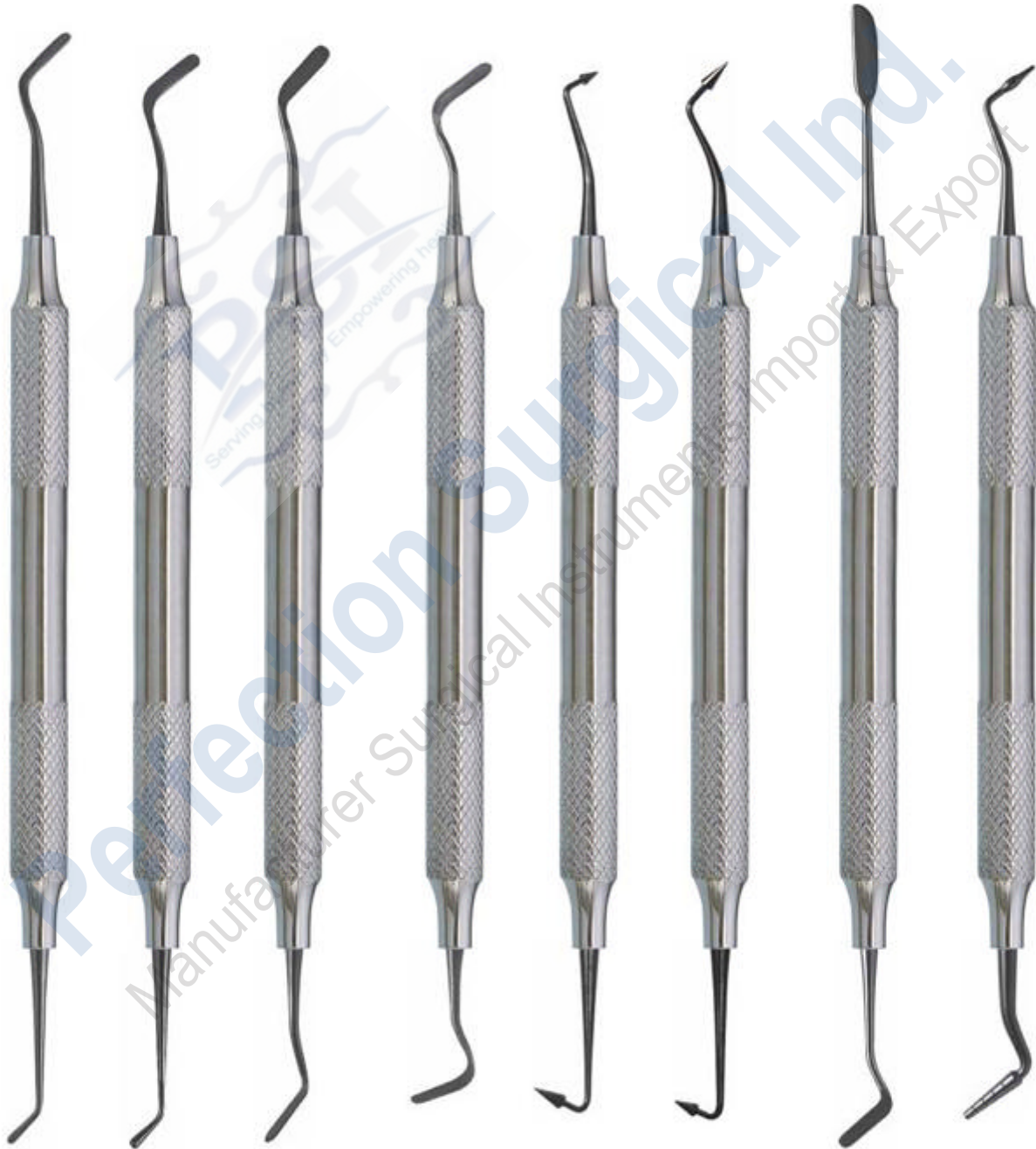

PS-2839
#1

PS-2840
#2

PS-2841
#3
Extra-Flex

PS-2842
#4
Extra-Flex

PS-2843
#5
Flexi-Thin

PS-2844
#6
Flexi-Thin

PS-2845
AB1
Boghosian

PS-2846
AB2
Boghosian

IMPLANTOLOGY



- Инструменты для имплантологии
- Implantologie
- Implantologie

- Инструменти для имплантології
- Implantoloia
- زراعة الأسنان

BLACK TITANIUM COLOUR COATED INSTRUMENTS



PS-2847
A
Cosmetic
Contouring

PS-2848
B
Cosmetic
Contouring

PS-2849
C
Cosmetic
Contouring

PS-2850
D
Cosmetic
Contouring

PS-2851
F
Cosmetic
Contouring

PS-2852
Marginal Ridge
& Embrasure
Shaping Instrument

PS-2853
Occlusal
Anatomy
Instrument

- Инструменты для имплантологии
 - Implantologie
 - Implantologie
- Инструменти для имплантології
 - Implantologia
 - زراعة الأسنان

BLACK TITANIUM COLOUR COATED INSTRUMENTS

BURNISHERS

FREEDMAN BURNISHERS

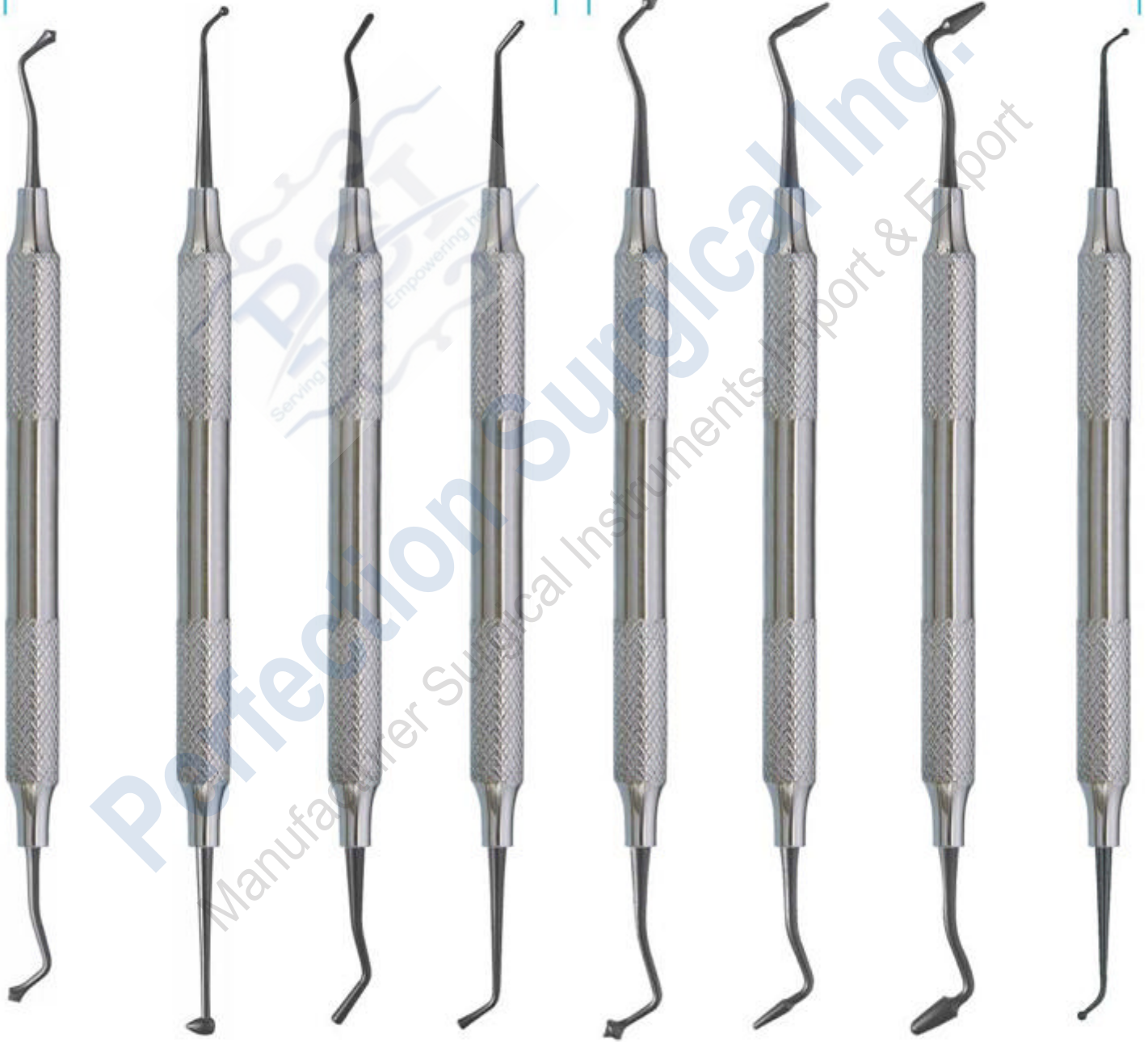

PS-2854
21B

PS-2855
27/29

PS-2856
2
Ladmore

PS-2857
3
Ladmore

PS-2858
Freedman
"Duckhead"

PS-2859
Freedman
Small Contact
Forming

PS-2860
Freedman
Large Contact
Forming

PS-2861
Small/
Medium Ball
Burnisher

IMPLANTOLOGY

- Инструменты для имплантологии
- Implantologie
- Implantologie

- Инструменти для имплантології
- Implantoloia
- زراعة الأسنان



SINUS LIFT INSTRUMENTS HOLLOW HANDLE 9.5MM LENGTH 170MM

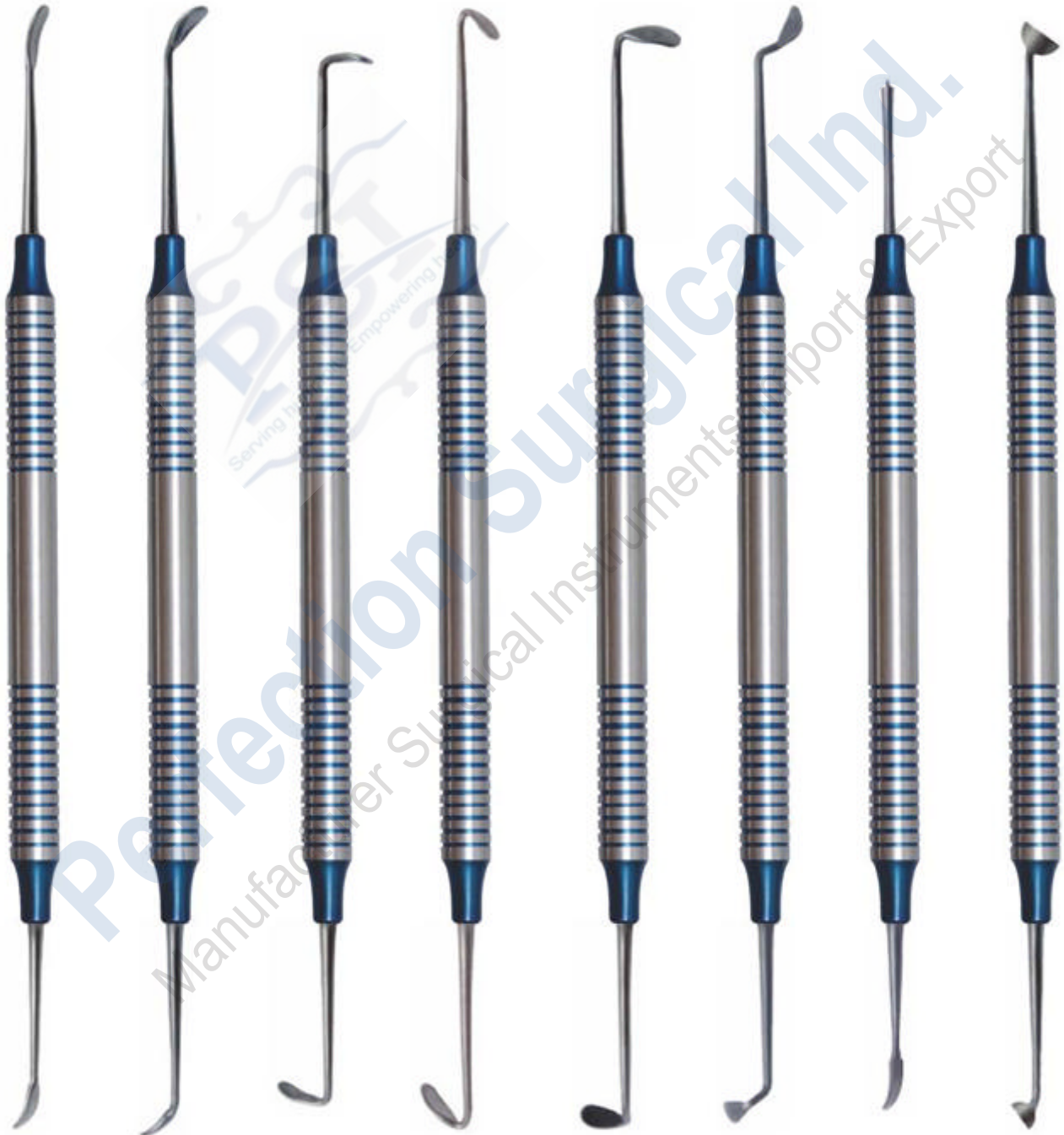

PS-2862
Sinuslift 1

PS-2863
Sinuslift 2

PS-2864
Sinuslift 3

PS-2865
Sinuslift 4

PS-2866
Sinuslift 5

PS-2867
Sinuslift 6

PS-2868
Membrane
3Positioning 1

PS-2869
Condenser 1

IMPLANTOLOGY

- Инструменты для имплантологии
- Имплантология
- Implantologie
- Инструменти для имплантології
- Implantologia
- زراعة الأسنان

Sinus Lift Instrument,
Flexible Sinus Lift instruments
reduce the risk of perforation of the
"Schneider's membrane"

Sinus Lift Elevator,
10 mm Straight grip
Length 175 mm, Sinus lift elevators, dull,
for gentle peeling and lifting the
Schneider membrane

Sinus lift instrument
10 mm Straight grip Length 180 mm,
Buser (B1, B2, B3) raspatories,
quality medical stainless steel,
corrosion-resistant

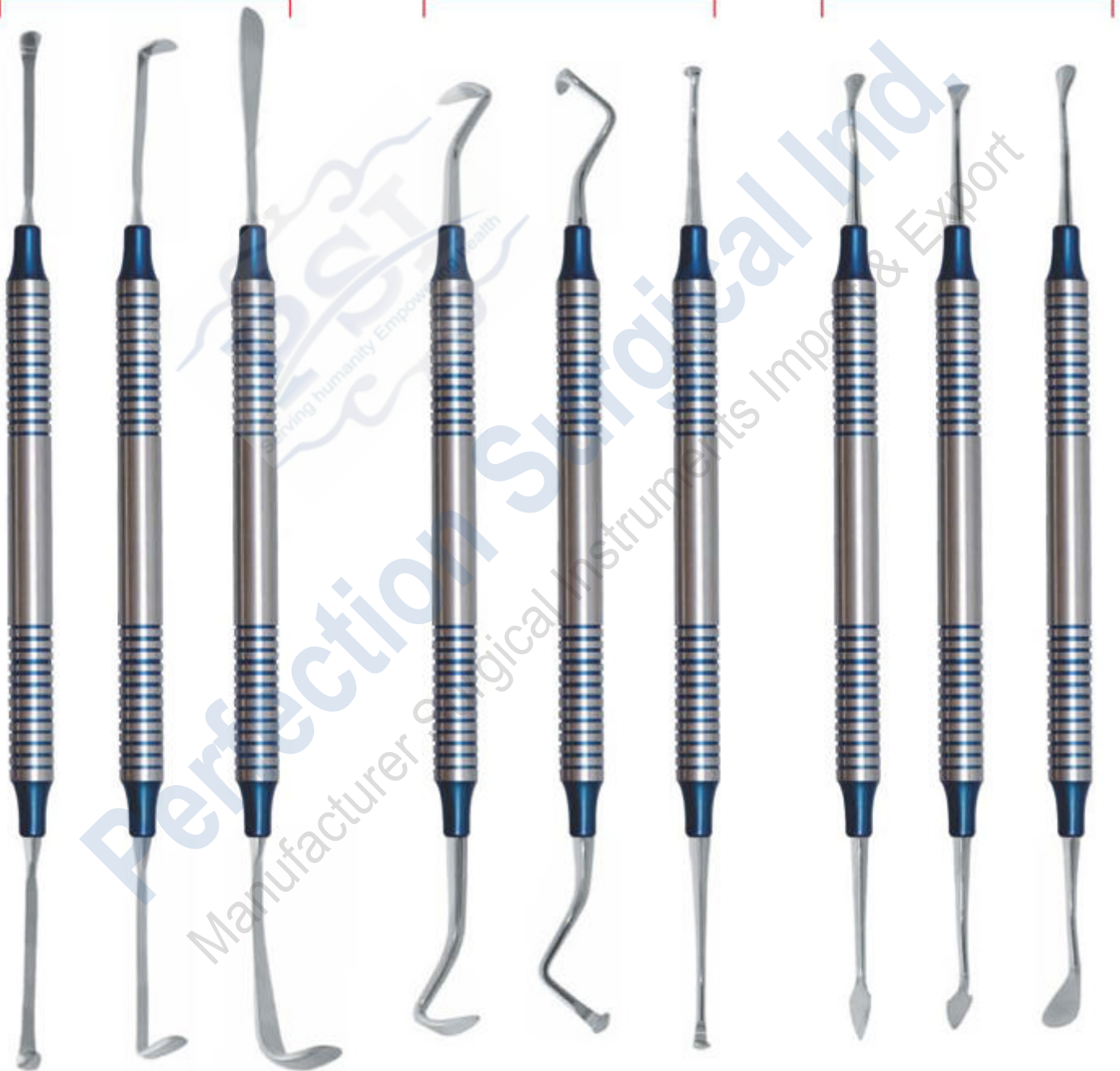

PS-2870
Fig. 1

PS-2871
Fig. 2

PS-2872
Fig. 3

PS-2873
Fig. 1

PS-2874
Fig. 2

PS-2875
Fig. 3

PS-2876
B01

PS-2877
B02

PS-2878
B03

IMPLANTOLOGY



- Инструменты для имплантологии
- Implantologie
- Implantologie
- Инструменти для имплантології
- Implantoloia
- زراعة الأسنان

Sinus lift instrument 10 mm Straight grip Sinus lift elevators, blunt or sharply curved (H01, H02, K03, K04, K78, K77)

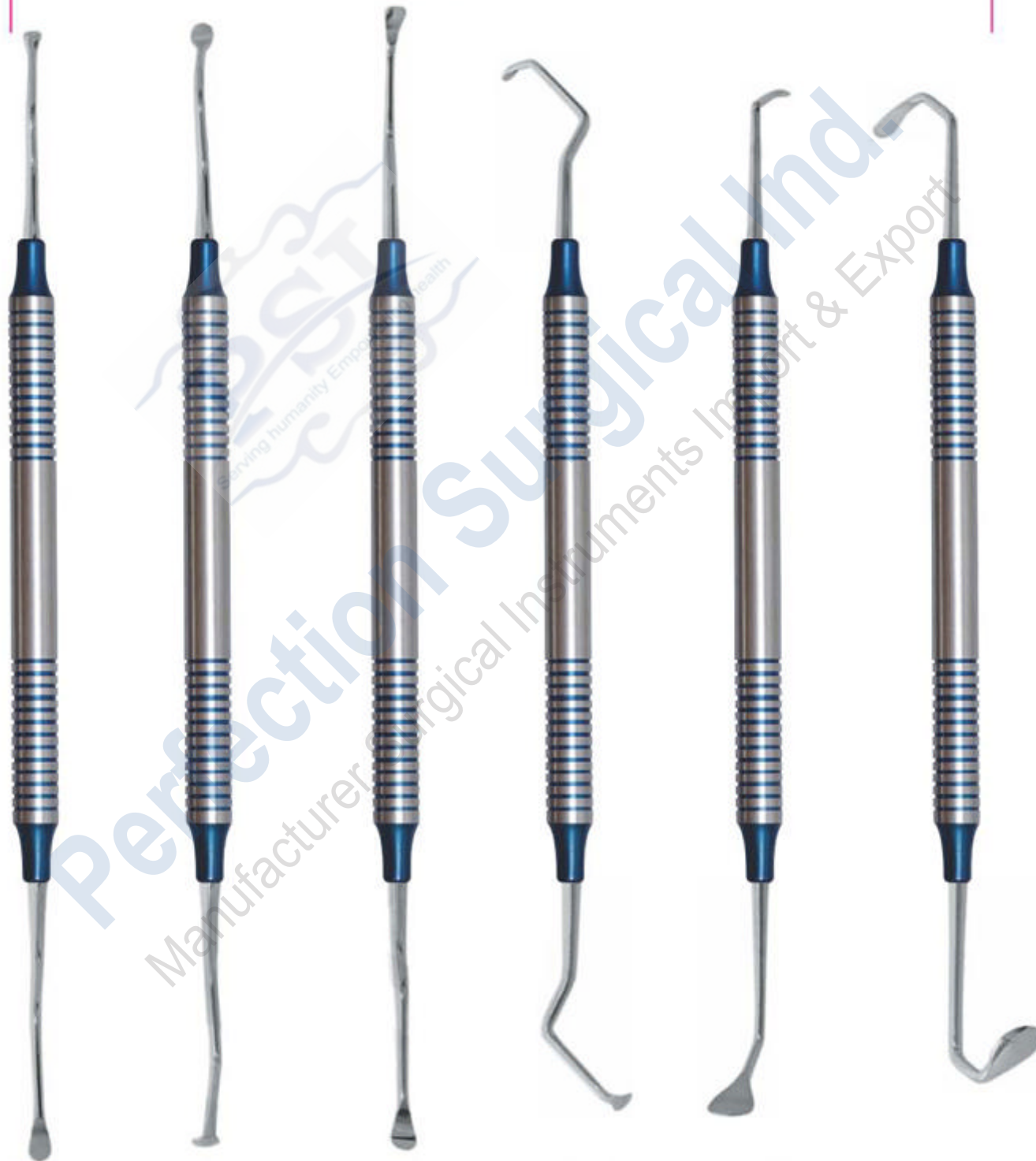

PS-2879
Sinus lift
instrument
H01

PS-2880
Sinus lift
instrument
H02

PS-2881
Sinus lift
instrument
K03

PS-2882
Sinus lift
instrument
K04

PS-2883
Sinus lift
instrument
K78

PS-2884
Sinus lift
instrument
K77

IMPLANTOLOGY

- Инструменты для имплантологии
 - Implantologie
 - Implantologie
- Инструменти для імплантології
 - Implantologia
 - زراعة الأسنان

Composite Filling Instruments Set of 6 Pcs



PS-2885



PS-2886

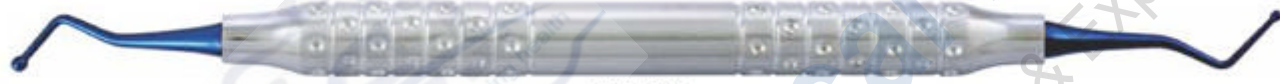

PS-2887

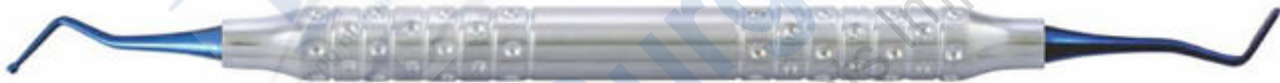

PS-2888



PS-2889



PS-2890

COMPOSITE INSTRUMENTS USE:

A composite (tooth colored) filling is used to repair a tooth that is affected by decay, cracks, fractures, etc. The decayed or affected portion of the tooth will be removed and then filled with a composite filling.

There are many types of filling materials available, each with their own advantages and disadvantages. You and your dentist can discuss the best options for restoring your teeth. Composite fillings, along with silver amalgam fillings, are the most widely used today. Because composite fillings are tooth colored, they can be closely matched to the color of existing teeth, and are more aesthetically suited for use in front teeth or the more visible areas of the teeth.

As with most dental restorations, composite fillings are not permanent and may someday have to be replaced. They are very durable, and will last many years, giving you a long lasting, beautiful smile.

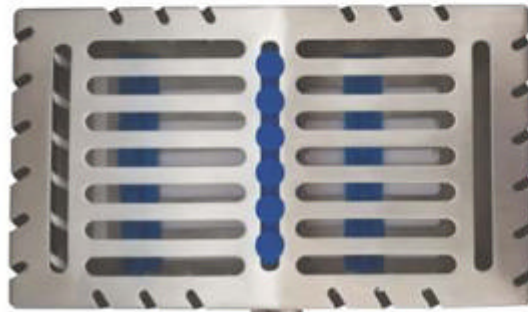
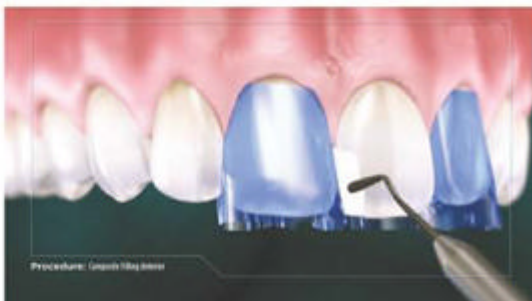

PS-2891

IMPLANTOLOGY



- Инструменты для имплантологии
- Implantologie
- Implantologie
- Инструменти для имплантології
- Implantologia
- زراعة الأسنان

Set of 5 Composite Gold Tip Instruments
PS-2892



Set of 4 Composite Blue Tip Instruments
PS-2893



Set of 3 Composite Blue Tip Instruments
PS-2894



Set of 2 Composite Blue Tip Instruments
PS-2895



PS-2896 Periosteal Elevators Molt # 9

PS-2897 Endodontic explorer DG # 16

IMPLANTOLOGY

- Инструменты для имплантологии
 - Implantologie
 - Implantologie
- Інструменти для імплантології
 - Implantologia
 - زراعة الأسنان

VISTA TUNNELING INSTRUMENTS SET



PS-2898



PS-2899



PS-2900



PS-2901

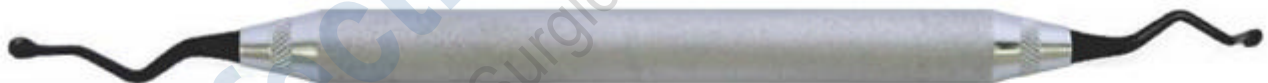

PS-2902



PS-2903

PS-2904



IMPLANTOLOGY



- Инструменты для имплантологии
- Implantologie
- Implantologie

- Инструменти для имплантології
- Implantoloia
- زراعة الأسنان



PS-2905
used for elevation of sinus membrane



PS-2906
used for elevation of sinus membrane

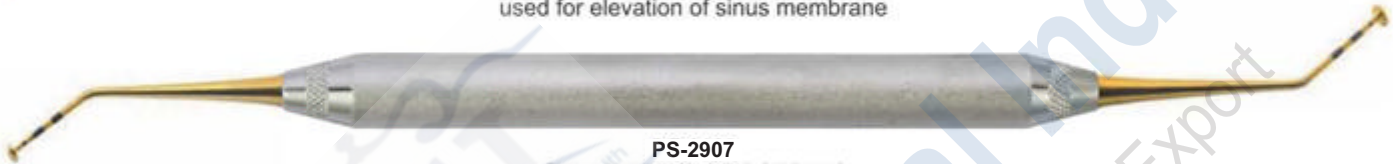

PS-2907
Cobra in / out (2-4-5-6-8-10mm)



PS-2908
Cobra 3.5mm

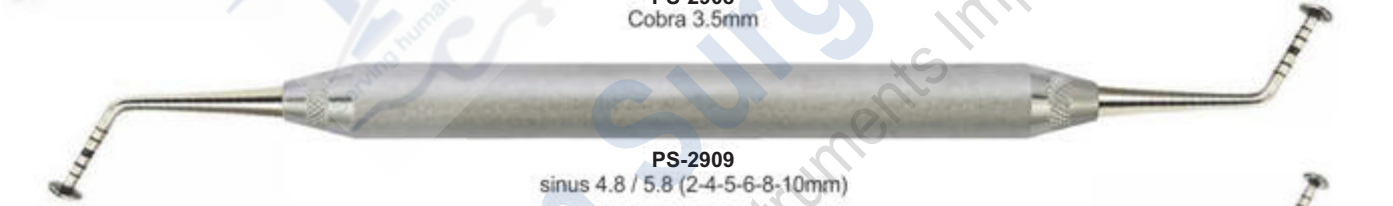

PS-2909
sinus 4.8 / 5.8 (2-4-5-6-8-10mm)



PS-2910
sinus 2.8 / 3.8 (2-4-5-6-8-10mm)



PS-2911
Bone Graft 3.8SP / 2.8mm (2-4-5-6-8-10mm)



PS-2912
Cobra in / out (2-4-5-6-8-10mm)



PS-2913
Cobra 3.5mm



PS-2914
Gold Color Set Dental Oral Implantology Sinus Set of 10 Pcs with cassette

IMPLANTOLOGY

- Инструменты для имплантологии
- Implantologie
- Implantologie
- Инструменти для імплантології
- Implantologia
- زراعة الأسنان



PS-2915
Sinus Lift elevator 1



PS-2916
Sinus Lift elevator 2



PS-2917
Sinus Lift elevator 3



PS-2918
Sinus Lift elevator 4



PS-2919
Sinus Lift elevator 5



PS-2920
Sinus Lift elevator 6



PS-2921
Sinus Lift Elevators Set of 7 Pcs
with cassette

IMPLANTOLOGY



- Инструменты для имплантологии
- Implantologie
- Implantologie
- Инструменти для имплантології
- Implantologia
- زراعة الأسنان

Sinus Left Elevator Set of 10 Pcs



IMPLANTOLOGY

- Инструменты для имплантологии
 - Implantologie
 - Implantologie
- Инструменти для імплантології
 - Implantologia
 - زراعة الأسنان

Blue Titanium Coated Bone Grafting Instruments



PS-2932

Bone Graft 1.0 / 1.7 mm Titanium 8. 11. 13. 15. 18 mm

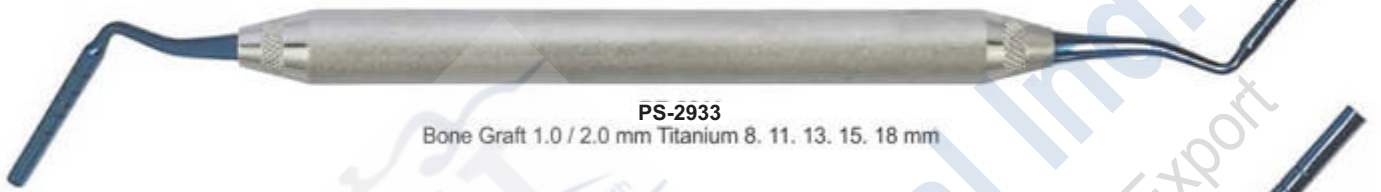

PS-2933

Bone Graft 1.0 / 2.0 mm Titanium 8. 11. 13. 15. 18 mm



PS-2934

Bone Graft 2.4 / 2.7 mm Titanium 8. 11. 13. 15. 18 mm

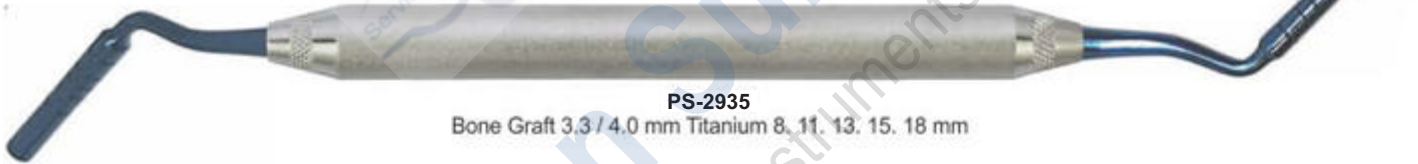

PS-2935

Bone Graft 3.3 / 4.0 mm Titanium 8. 11. 13. 15. 18 mm



PS-2936

Bone Graft 3.3 / 4.0 mm Titanium Coated Tips



PS-2937

Bone Graft / Carrier Titanium 8. 11. 13. 15. 18 mm

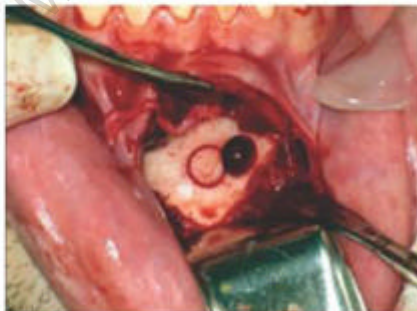

PS-2938

Blue Titanium Coated Bone Grafting Instruments Set of 7 Pcs with cassette

IMPLANTOLOGY



- Инструменты для имплантологии
- Implantologie
- Implantologie

- Инструменти для имплантології
- Implantologia
- زراعة الأسنان



PS-2939
Fig. 1



PS-2940
Fig. 2



PS-2941
Fig. 3



PS-2942
Fig. 4



PS-2943
Fig. 5



PS-2944
Fig. 6

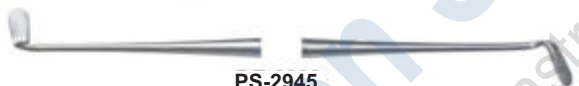

PS-2945



PS-2946



PS-2947



PS-2948



PS-2949

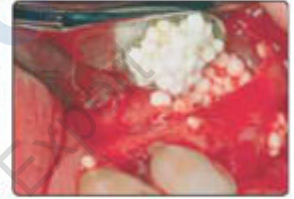
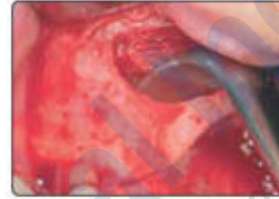

Flexible Sinus-Lift Curettes – for an optimum sensitivity during the direct lift procedure

The perforation of the Schneiderian membrane is a complication that often occurs during a maxillary sinus floor augmentation procedure. The Sinus-Lift Instruments increase the sensitivity by blunt and flexible working tips with "Swing-Effect". Because of their special shapes and the characteristic of the stainless steel between the handle and the active part, light pressure is cushioned and gives the operator a direct and sensitive response. At the same time the risk to perforate the Schneiderian membrane is reduced to a minimum. Already at the development the focus was a practicable handling. Because of varying angulations and shapes of the active parts also in difficult areas they are easy to navigate also in difficult areas. The line of curettes consists of six different figures for every situation. They are complemented by spoon and condenser to place the bone graft.



The "Schneider's Membrane" of the sinus can be detached with curette by 1–2mm along the total cortical bone.



Curette is particularly useful in the lower part for detaching the membrane further. The same goes for the caudal area, especially when the membrane is 4–5 mm above the base of the maxillary sinus and the maxillary sinus is built up with granular material.



Curette makes it possible to lift the membrane further in mesial region. One working tip is especially designed for the right maxillary sinus and the other for the left maxillary sinus.



With curette the sinus membrane is further elevated in the upper and posterior part of the maxillary sinus wall.



With curette the sinus membrane is further detached over a broad area in the inner region, especially along the roof of the palate.

IMPLANTOLOGY

- Инструменты для имплантологии
- Implantologie
- Implantologie
- Инструменти для имплантології
- Implantologia
- زراعة الأسنان

IMPLANT SINUS LIFT INSTRUMENTS HOLLOW HANDLE 9.5MM LENGTH 170MM



PS-2950
Acute 6577



9 Pcs of Set
PS-2958

SINUS LIFT INSTRUMENTS HOLLOW HANDLE 9.5MM LENGTH 170MM



PS-2959
Sinuslift 1



9 Pcs of Set
PS-2967

IMPLANTOLOGY



- Инструменты для имплантологии
- Implantologie
- Implantologie
- Инструменти для имплантології
- Implantoloia
- زراعة الأسنان

IMPLANT SINUS LIFT INSTRUMENTS PERIODONTAL SURGERY SURGICAL CHISELS KRAMER NEVINS SINUS LIFT

SURGICAL CHISELS



PS-2968
TG



PS-2969 SOLT3/4



PS-2970 TGO



PS-2971 OCH3



PS-2972 OCH4



PS-2973 FEDI1



PS-2974 FEDI2



PS-2975 FEDI3



PS-2976 13K/TG 3mm



PS-2977 13K/TG Titanium 3mm



PS-2978 13K/TG 4.5mm



PS-2979 13KL/R Titanium 4.5mm



PS-2980 13KL 4/6mm Titanium Available 6mm



PS-2981
Cassette For Instruments

IMPLANTOLOGY

- Инструменты для имплантологии
 - Implantologie
 - Implantologie
- Инструменти для імплантології
 - Implantologia
 - زراعة الأسنان

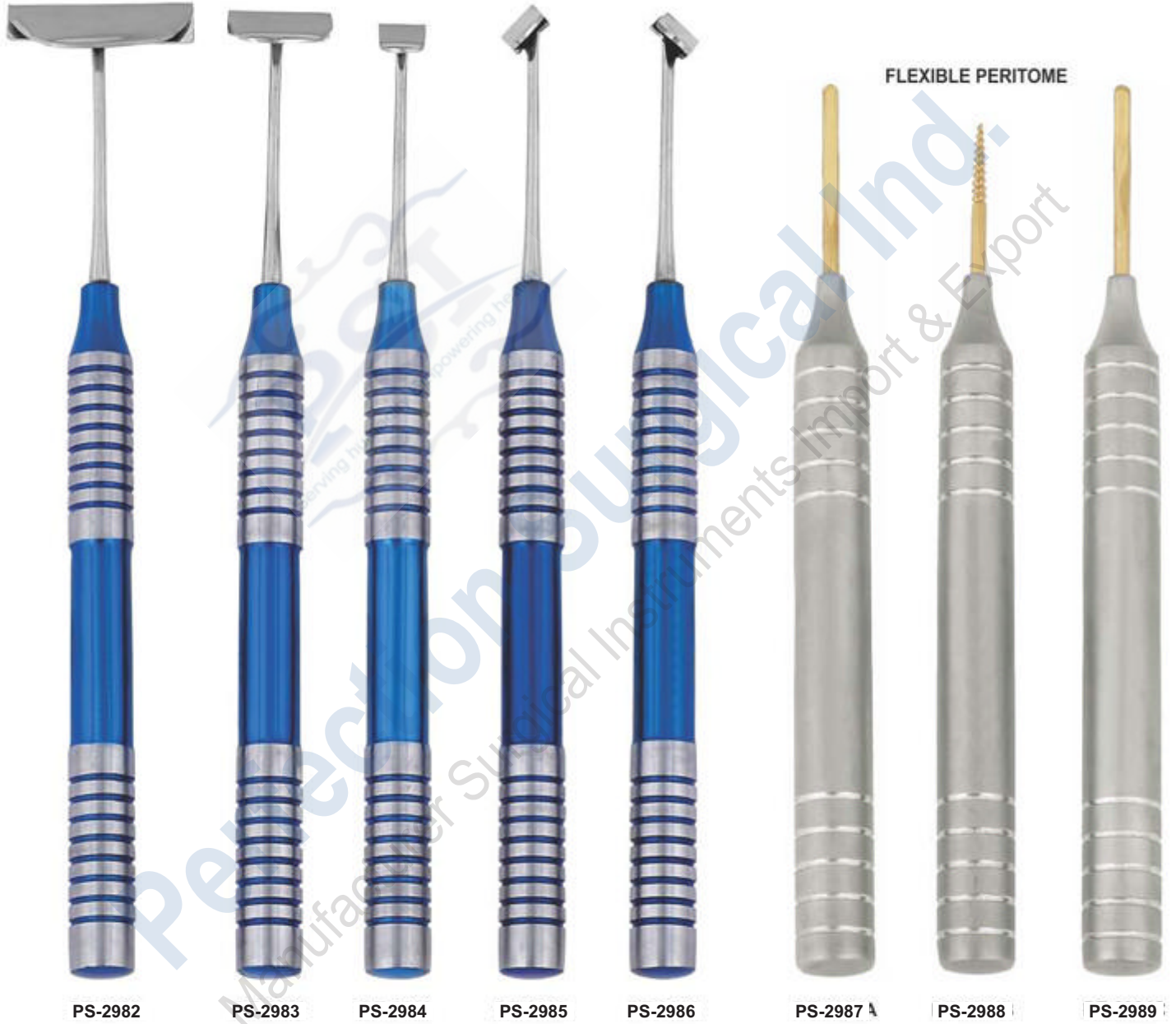

Soft Brushing Kit Set of 6 Pcs



IMPLANTOLOGY



- Инструменты для имплантологии
- Implantologie
- Implantologie
- Инструменти для имплантології
- Implantoloia
- زراعة الاسنان

SINUS ELEVATOR & MEMBRANE LIFT TIPS



PS-2990
Membrane Detach Elevator



PS-2991
Membrane Elevator



PS-2992
Membrane Elevator



PS-2993
Membrane Elevator



PS-2994
Membrane Elevator



PS-2995
Bone Graft Packer



PS-2996 A Pt2 Titanium
A/V Regular



PS-2996 B Pt1 Titanium
A/V Regular



PS-2996 C Pt3 Titanium Angel S/E



PS-2996 D Pt4 Titanium STR S/E



PS-2996 E Pt5 Titanium TG CVD S/E



PS-2997
Sinus Left Elevator & Membrane Lift Tips
set of 7 Pcs

- Инструменты для имплантологии
- Implantologie
- Implantologie
- Инструменти для імплантології
- Implantologia
- زراعة الأسنان

MIXING SPATULA WITH SHOVEL



PS-2998
Bone Carrier
Titanium



PS-2999
Raspator, Prichard
Length 180 mm,
10 mm hollow handle,
double-ended
10.5 mm | 4.5 mm,



PS-3000
Raspator, Prichard
Length 180 mm,
10 mm hollow handle,
double ended



PS-3001
Raspator, Prichard
Length 180 mm,
10 mm hollow handle,
double-ended
10.5 mm | 4.5 mm,



PS-3002
Mixing Spatula
with shovel
17cm



PS-3003
Mixing Spatula
with shovel
18.5cm



PS-3004
Graft Material Spoon
Concave Tip For
Larger Grafts

IMPLANTOLOGY



- Инструменты для имплантологии
 - Implantologie
 - Implantologie
- Инструменти для имплантології
 - Implantologia
 - زراعة الأسنان

BONE GRAFTING INSTRUMENTS COMPACTOR /TAMPERS

Product offering includes instruments for harvesting, mixing and compacting bone Provides clinicians with the proper instrumentation for bone grafting procedures Weighted bone basin Prevents tipping and spilling of bone and other materials during mixing



PS-3005
Graft Packer, Concave Tips DE 4/6mm



PS-3006
Bone Spoon/ Packer DE 3mm



PS-3007
Blade and pusher Length 180 mm, for straight or angled, blade: 15 x 5 mm, pusher: 4 mm diameter Straight

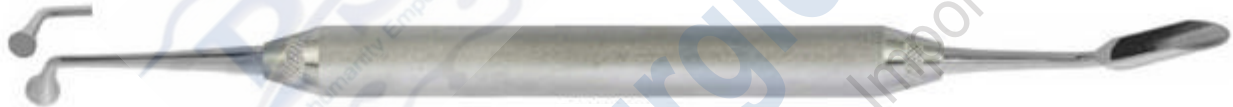

PS-3008
Blade and pusher Length 180 mm, for straight or angled, blade: 15 x 5 mm, pusher: 4 mm diameter angular

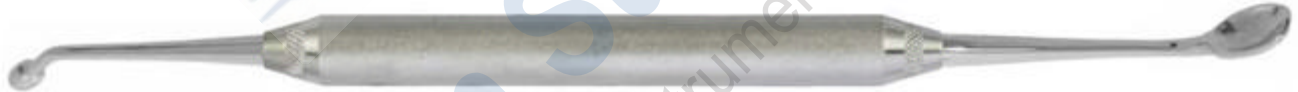

PS-3009
Spoon and pusher Length 180 mm, for angled spoon: 10 x 5 mm, pusher: diameter 3 mm



PS-3010
Graft Packer, Smooth Tips DE 5/8mm



PS-3011
Graft Packer, Serrated Tips DE 3/4mm



PS-3012
Graft Packer, Serrated Tips DE 6/8mm



PS-3013
Titanium graft packer/placement site depth gauge 3.3mm & 4.0mm Diameter tips Marked at 8, 11, 13, 15 & 18mm



PS-3014
Tamper Length 170 mm, for bone material, double-ended, diameter 3.2 mm (2-4-6-8-10) and diameter 2.5mm (2-4-6-8-10)

- Инструменты для имплантологии
 - Implantologie
 - Implantologie
- Инструменти для імплантології
 - Implantologia
 - زراعة الأسنان

SPOON AND PUSHER (TRINOVO)

Trinovo handle, different workers, for bone material, high-grade medical stainless steel, corrosion-resistant

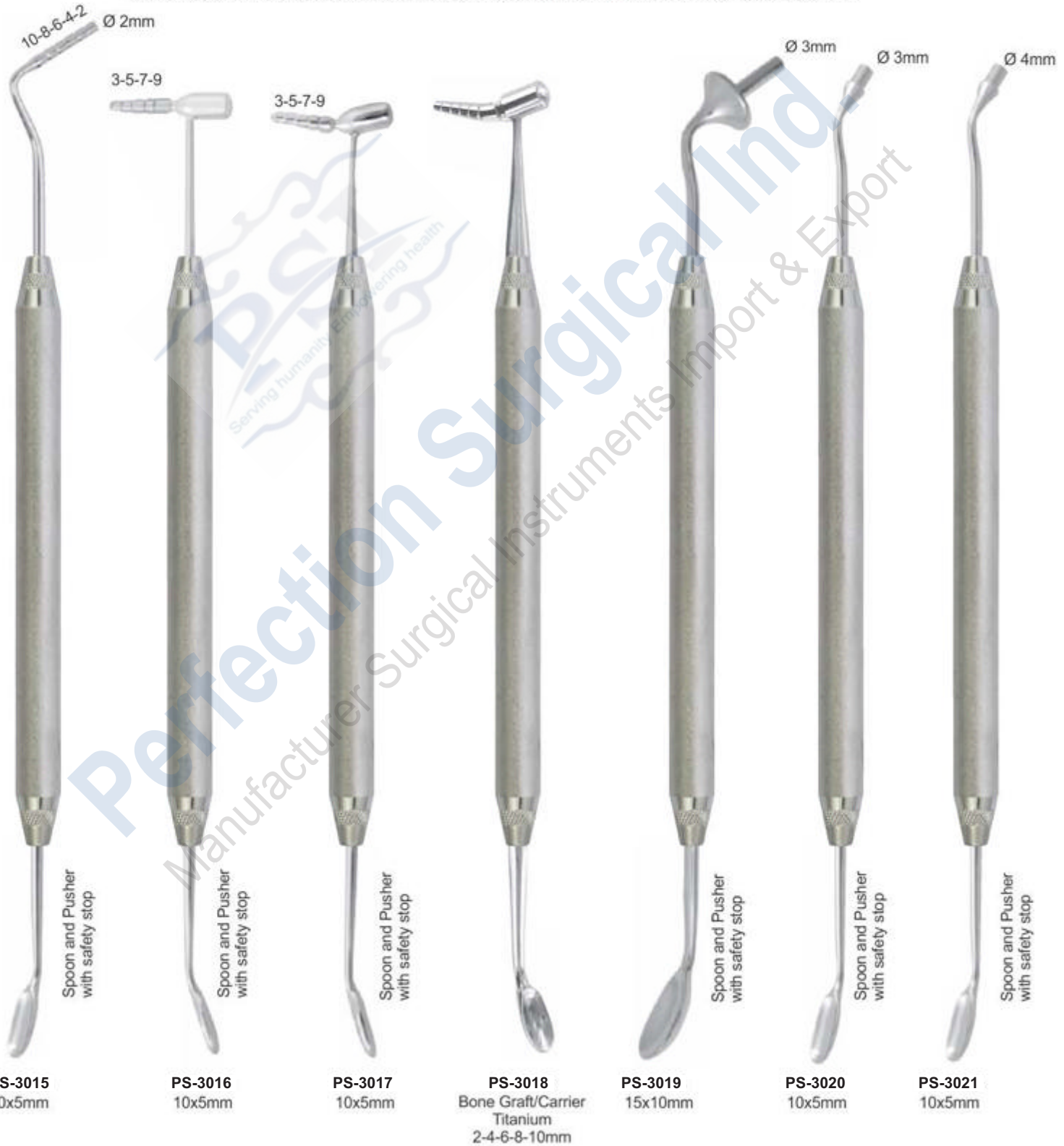

IMPLANTOLOGY



- Инструменты для имплантологии
- Implantologie
- Implantologie

- Инструменти для имплантології
- Implantologia
- زراعة الأسنان

Hollow Handle 10mm Length 170mm



PS-3022 Miller



PS-3023 Miller



PS-3024 LUCAS #84



PS-3025 LUCAS #85



PS-3026 LUCAS #86



PS-3027 LUCAS #87



PS-3028 LUCAS #88



PS-3029 LUCAS86S
SERRATED



PS-3030 LUCAS86AS
SERRATED

- Инструменты для имплантологии
- Implantologie
- Implantologie
- Инструменти для имплантології
- Implantologia
- زراعة الأسنان

TISSUE MEMBRANE FORCEPS



PS-3031
Tissue Graft Forcep
Serrated Teeth



PS-3032
Self Locking
Grooved



PS-3033
Tissue Graft Forcep
Serrated Teeth



PS-3034
Titanium
Locking Plier



PS-3035
TC Gripper Carbide
Tipped Tissue Forceps
Serrated Carbide Tips
14.5cm



PS-3036
Adson Carbide
Tipped Tissue Forceps
Serrated Carbide Tips
12cm



PS-3037
Micor Adson 1x2
Tissue Forcep 12.1cm
1x2 Teeth - 0.5mm Tips



PS-3038
Adson 7x7
Tissue Forceps
7x7 Teeth 12cm



PS-3039
Adson 7x7 Curved
Tissue Forceps
7x7 Teeth 12cm



PS-3040
Suture Pliers
Suture Forceps with
1.6mm Ring Tip



PS-3041
Debakey Atraumatic
Tissue Forceps Straight
Serrated Teeth
16cm



PS-3042
Debakey Atraumatic
Tissue Forceps Curved
Serrated Teeth
16cm

IMPLANTOLOGY



- Инструменты для имплантологии
- Implantologie
- Implantologia
- زراعة الأسنان
- Инструменти для имплантології
- Implantoloia

TISSUE MEMBRANE FORCEPS



PS-3043
Russian Long
Tissue Forceps
Serrated Tip
20cm



PS-3044
Russian
Tissue Forceps
Serrated Tip
15cm



PS-3045
Tissue Punch Forceps
To Remove Tissue
After Using Punch



PS-3046
13.5 cm
narrow



PS-3047
10.5 cm
Membrane tweezers KUEHNE



PS-3048
13.5 cm
wide



PS-3049
Pin-Tweezers
with or without lock,
length 15 cm,
with lock



PS-3050
without lock



PS-3051
Haltepinzette with lock
15,5 cm, for pins, towards
the tips, etc



PS-3052
Carry Forceps
15cm



PS-3053
Carry Forceps
15cm



PS-3054
Carry Forceps
15cm

- Инструменты для имплантологии
- Implantologie
- Implantologie
- Инструменти для імплантології
- Implantologia
- زراعة الأسنان

OSTEOTOME CONVEXES / CONCAVE / CONIQUES

CONVEXES

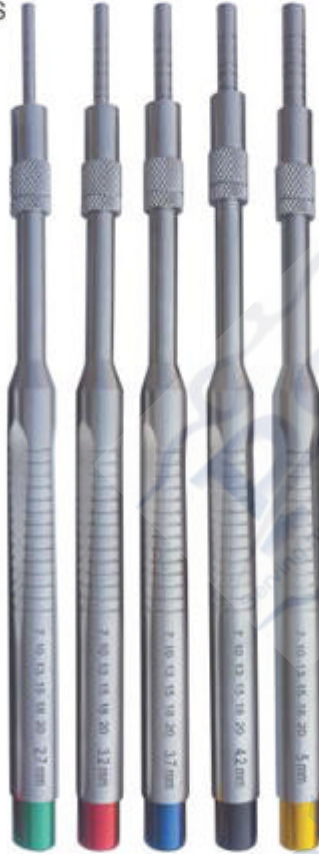

PS-3055
SET OF 5 PIECES

CONCAVES



PS-3056
SET OF 5 PIECES

CONIQUES



PS-3057
SET OF 5 PIECES

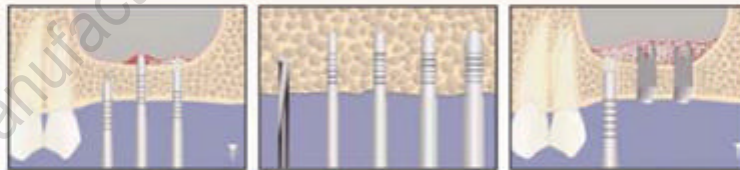

	CONVEXES STRAIGHT	PS-3058	2,7 Ømm	3,2 Ømm	3,7 Ømm	4,2 Ømm	5 Ømm
	CONCAVES STRAIGHT	PS-3059	2,7 Ømm	3,2 Ømm	3,7 Ømm	4,2 Ømm	5 Ømm
	CONIQUES STRAIGHT	PS-3060	2,7 Ømm	3,2 Ømm	3,7 Ømm	4,2 Ømm	5 Ømm

IMPLANTOLOGY



- Инструменты для имплантологии
- Implantologie
- Implantologia
- زراعة الأسنان

OSTEOTOME CONVEXES / CONCAVE / CONIQUES





PS-3061
SET OF 5 PIECES

PS-3062
SET OF 5 PIECES

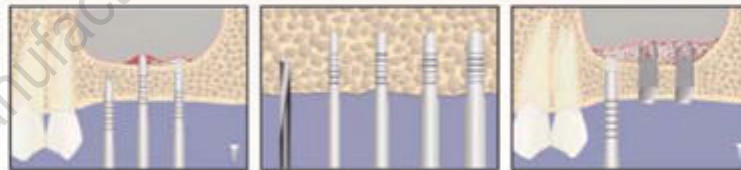
PS-3063
SET OF 5 PIECES



	CONVEXES CURVED	PS-3064	2,7 Ømm	3,2 Ømm	3,7 Ømm	4,2 Ømm	5 Ømm
	CONCAVES CURVED	PS-3065	2,7 Ømm	3,2 Ømm	3,7 Ømm	4,2 Ømm	5 Ømm
	CONIQUES CURVED	PS-3066	2,7 Ømm	3,2 Ømm	3,7 Ømm	4,2 Ømm	5 Ømm

- Инструменты для имплантологии
 - Implantologie
 - Implantologie
- Инструменти для імплантології
 - Implantologia
 - زراعة الأسنان

BONE SCRAPER STRAIGHT & CURVED



PS-3067
Bone Scraper
Straight



PS-3068
Bone Scraper
Curved

TISSUE PUNCH STRAIGHT & CURVED



Tissue Punch
Straight

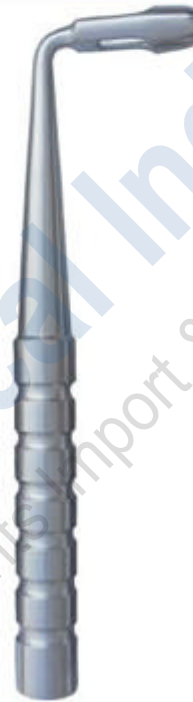
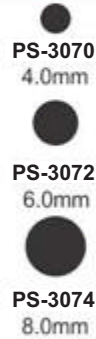

Tissue Punch
Curved

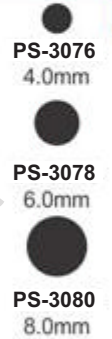

PS-3081
Tissue Punch with pin
Set of Four Pieces



PS-3082
Tissue Punch
Set of Five Pieces



PS-3083
Tissue Punch
Set of Five Pieces

IMPLANTOLOGY



- Инструменты для имплантологии
- Implantologie
- Implants
- Implants
- زراعة الأسنان

BONE MILL BONE WELL

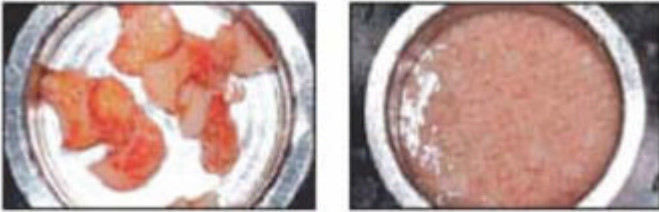

IMPLANTOLOGY

- Инструменты для имплантологии
- Implantologie
- Implantologie
- Инструменти для имплантології
- Implantologia
- زراعة الأسنان

TREPHINE

Burs with depth markings are suited for precise and simple transplantation of cylindrical bone grafts as well as for all other bone-extraction tasks.



PS-3099
Trepine Drill
Set of Eight Pieces



PS-3100
Trepine Drill
Set of Eight Pieces

BONE INJECTORS, COLLECTORS & SUCTION TUBE

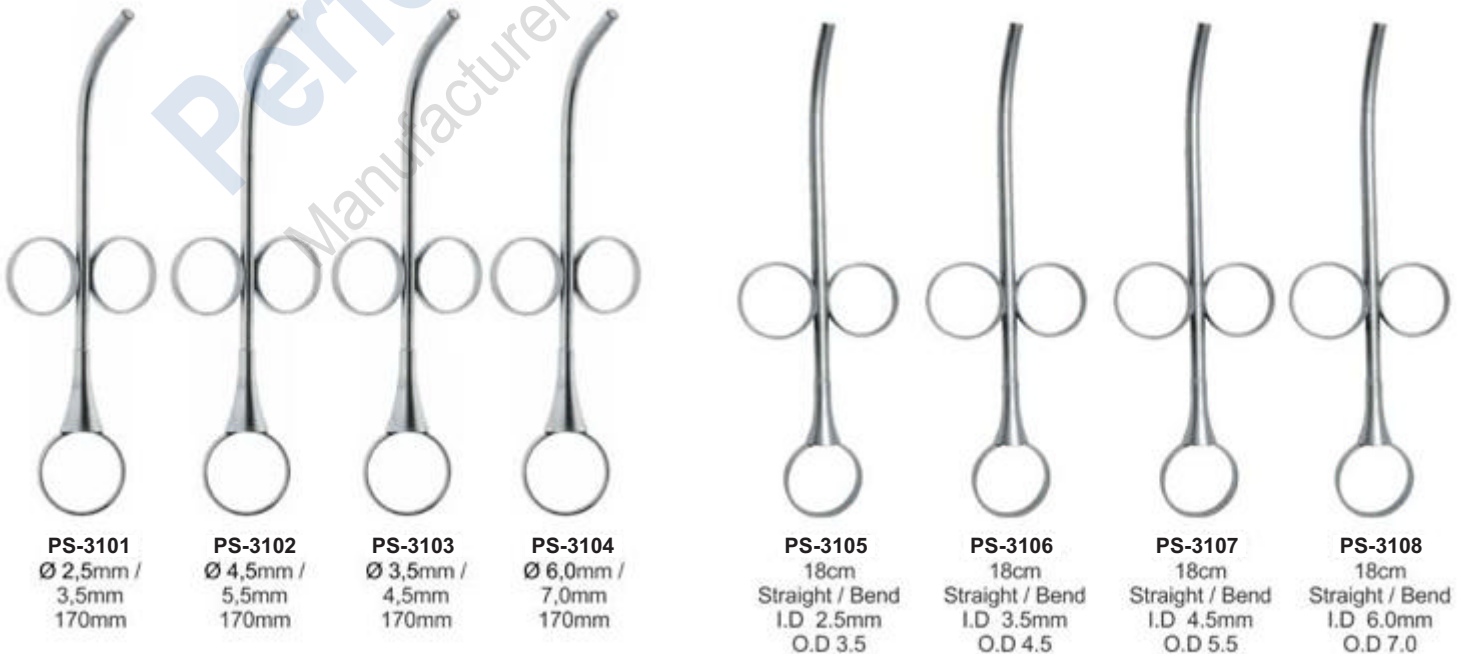

IMPLANTOLOGY



- Инструменты для имплантологии
- Implantologie
- Implantologie
- Инструменти для имплантології
- Implantoloia
- زراعة الأسنان

BONE EXPANDER SCREW & SURGICAL KITS



Ø2.0mm Ø2.5mm Ø2.8mm

PS-3109 Short Implant Drills



Ø3.2mm Ø3.65mm Ø4.2mm Ø5.2mm

PS-3110 Long Implant Drills



PS-3111

Bone Universal Kit

Drill: 2mm, 2.8mm, 3.2mm, 3.65mm, 4.2mm, 4.5mm, 4.8mm, 5.2mm
 Trephines Bit: 3.0mm, 4.0mm, 5.0mm, 6.0mm, 7.0mm, 8.0mm, 9.0mm, 10mm.
 Driver: 2.5mm, 2.5mm Hand Pcs, 1.25mm, 1.25mm Hand Pcs
 Short Driver 2.5mm, Long Driver 2.5mm
 1.25mm, Short Hex Driver Hand Pcs
 1.25mm, Long Hex Driver Hand Pcs, Torque Wrench 4.0mm



PS-3112

Bone Expander Kit

Expander: 2.6mm, 3.0mm, 3.4mm, 3.8mm, 4.3mm
 Ratchet Driver, Parallel Pin
 Pilot Drill, Drill 1.4mm, Drill Driver 4mm
 Hand Driver 4mm, Ratchet 4.0mm



PS-3113

Bone Universal Kit

Drill: 2mm, 2.8mm, 3.2mm, 3.65mm, 4.2mm, 4.5mm, 4.8mm, 5.2mm
 Trephines Bit: 3.0mm, 4.0mm, 5.0mm, 6.0mm, 7.0mm, 8.0mm, 9.0mm, 10mm.

Bone Compression:

2mm, 3.3mm, 2.8mm, 4.2mm, 3mm, 3.5mm
 Driver: 2.5mm, 2.5mm Hand Pcs
 1.25mm, 1.25mm Hand Pcs
 Short Driver 2.5mm
 Long Driver 2.5mm
 1.25mm, Short Hex Driver Hand Pcs
 1.25mm, Long Hex Driver Hand Pcs
 Torque Wrench 6.35mm 1 Pcs



PS-3114

Conical Drills: 20 Pcs

Tissue Punches: 3.0mm, 3.50mm, 4.0mm, 4.5mm, 5.0mm, 6.0mm, 6.50mm
 Bone Expander: 1.6/3.8mm, 1.9/3.0mm, 2.1/3.6mm, 2.6/3.8mm, 2.9/4.3mm
 Drill Adapter: 1 Pcs
 1.25mm, 2.50mm Hex Driver Hand Pcs

Pilot Drill: 1.6mm

Drill Bit: 1.4mm, 1.6mm, 1.8mm, 2.0mm, 2.2mm
 Ratchet Driver: 4mm/6.35, 1.25/2.50
 Rimer: 3.2/4.7mm, 3.7/4.7mm
 Parallel Pin: 4.5mm, 2.5mm
 Double step Drill: 2.4/2.8mm
 Depth Gauge: 1 Pcs
 Torque Wrench 6.35mm Universal: 1 Pcs

- Инструменты для имплантологии
 - Implantologie
 - Implantologie
- Инструменти для імплантології
 - Implantologia
 - زراعة الأسنان

KEYS FOR IMPLANT SCREW



PS-3115



PS-3116



PS-3117



PS-3118

TORQUE WRENCH & RATCHET



PS-3119 Star Torque Wrench 6.35mm Universal



PS-3120 Round Torque Wrench 4.0mm Universal



PS-3121 Hex Driver With 4.0mm Driver



PS-3122 Star Torque Wrench 6.35mm Universal



PS-3123 Hex Torque Wrench 4.00mm Universal



PS-3124 Star Torque Wrench 6.35mm Universal



PS-3125 Star Torque Wrench 6.35mm Universal



PS-3126 Star Torque Wrench 6.35mm Universal



PS-3127 Star Torque Wrench 6.35mm Universal



PS-3128 Star Torque Wrench 6.35mm Universal



PS-3129 Star Ratchet Wrench 6.35mm Universal



PS-3130 Star Ratchet Wrench 6.35mm Universal



DE-2399 Star Ratchet Wrench 6.35mm Universal



DE-2400 Star Ratchet Wrench 4.0mm Universal



DE-2401 Round Ratchet Wrench 4.0mm Universal



DE-2402 Round Ratchet Wrench 3.35mm Universal



DE-2403 Star Ratchet Wrench 4.0mm Universal



DE-2404 Star Ratchet Wrench 6.35mm Universal

IMPLANTOLOGY



- Инструменты для имплантологии
- Implantologie
- Implantologie

- Инструменти для имплантології
- Implantoloia
- زراعة الأسنان



PS-3131
Suction Cannula Kit
with 3 Needles



Suction Pipe



Suction Needle
1mm



Suction Needle
1.5mm



Suction Needle
2mm



2cm

2.7cm

With Filter

PS-3132
17.5cm

PS-3133
18cm

PS-3134
coarse
Ø 5mm



PS-3135
fine
Ø 9mm

Suction tubes to collect
the extracted
bone material
180mm



1.5mm

3mm

5mm

PS-3136
Suction
Tubes
180mm

PS-3137
Suction
Tubes
180mm

PS-3138
Suction
Tubes
180mm



PS-3140
Ø 3 mm
length 180mm
PS-3141
Ø 4 mm
length 180mm
PS-3142
Ø 5 mm
length 180mm

PS-3139
Fig. 6FR
Frazier
15 cm - Ø 2 mm

IMPRESSION TRAYS

- Оттисковые ложки
 - Porte-empreinte
 - Abdrucklöffel
- Відбиткові ложки
 - Cubetas para impresiones
 - صواني الانطباع

PERFORATED WITH RIM LOCK

Set of 06 Pcs

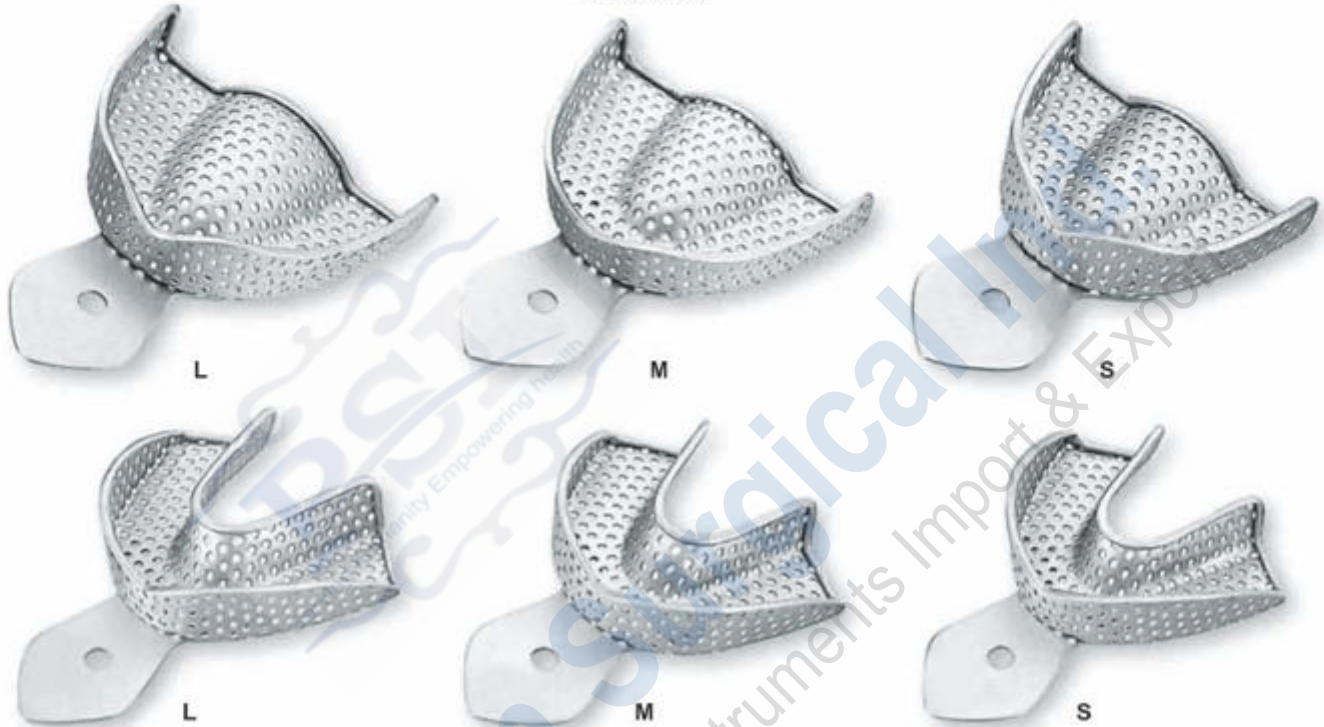

PS-3143 SET OF 06 PCS

Upper: S, M, L
Lower: S, M, L

PERFORATED WITH RIM LOCK

Set of 8 Pcs

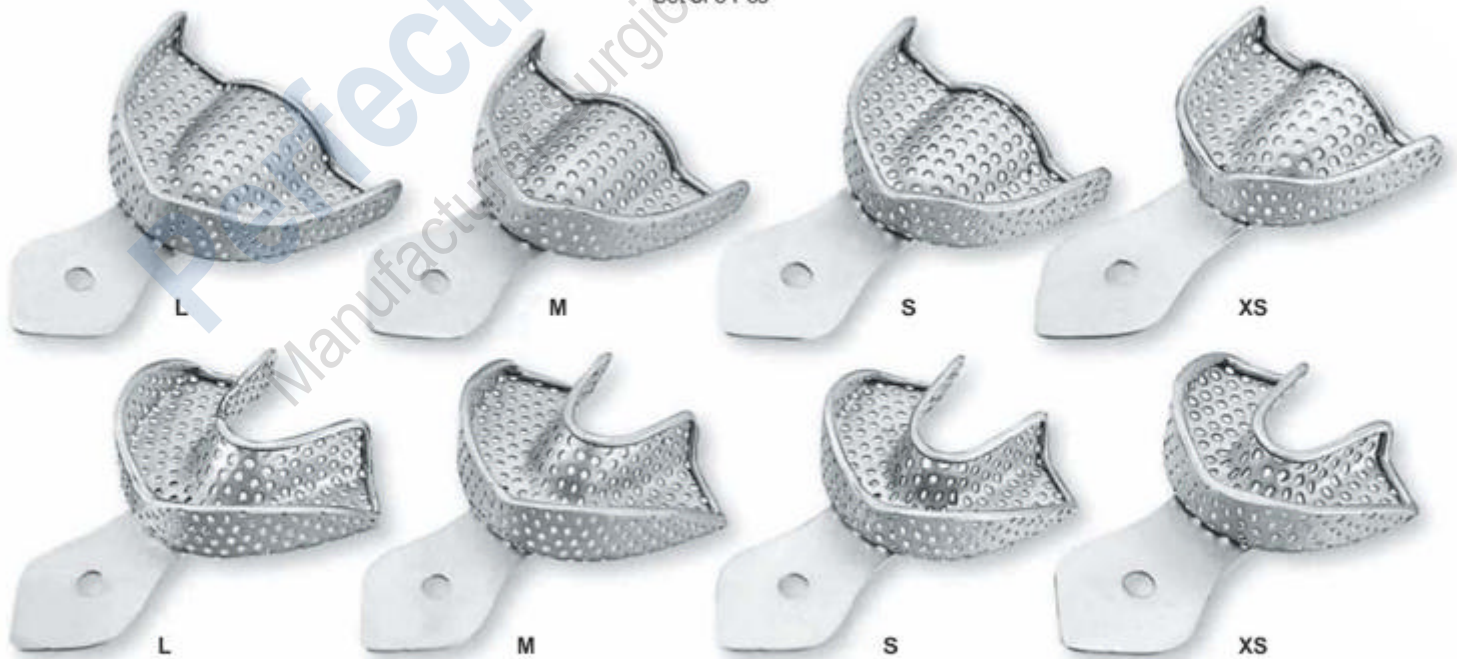

PS-3144 SET OF 08 PCS

Upper: XS, S, M, L
Lower: XS, S, M, L

PS-3145 SET OF 08 PCS

Upper: S, M, L, XL
Lower: S, M, L, XL

PS-3146 SET OF 10 PCS

Upper: XS, S, M, L, XL
Lower: XS, S, M, L, XL

IMPRESSION TRAYS



- Оттисные ложки
 - Porte-empreinte
 - Abdrucklöffel
- Відбиткові ложки
 - Cubetas para impresiones
 - صواني الانطباع

SOLID WITH RIM LOCK

Set of 6 Pcs

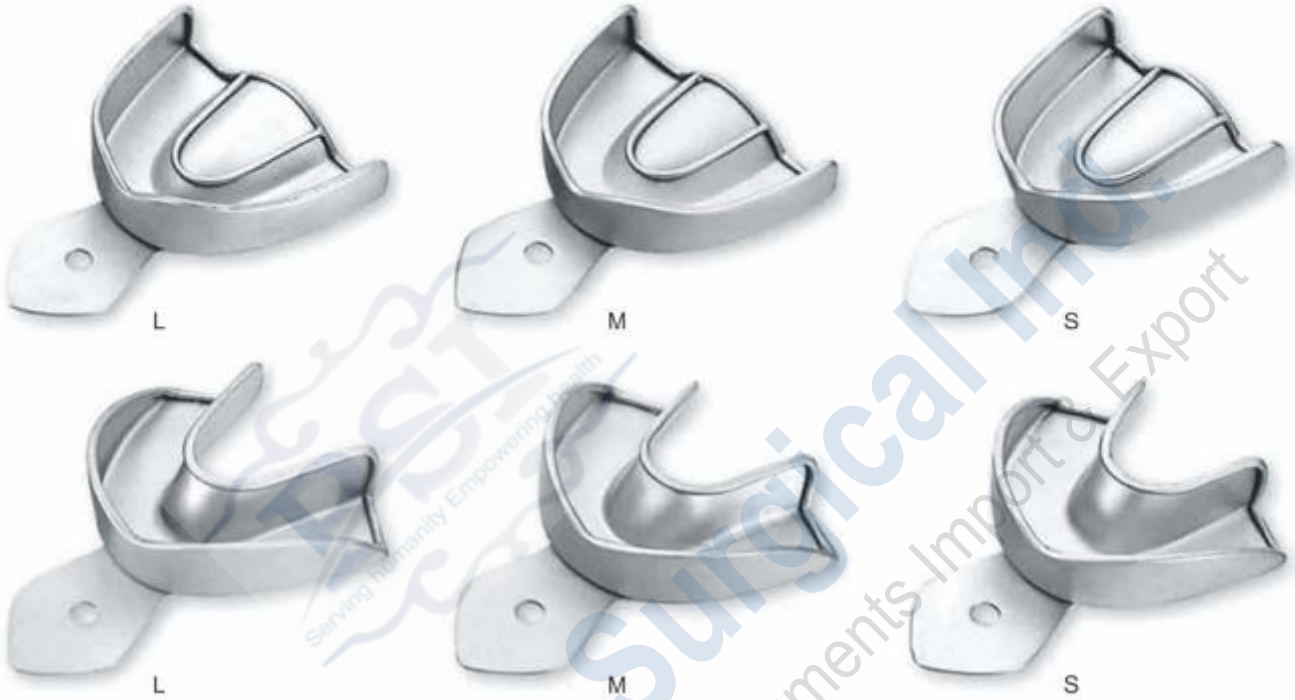

PS-3147 SET OF 06 PCS
Upper: S, M, L
Lower: S, M, L

SOLID WITH RIM LOCK

Set of 8 Pcs

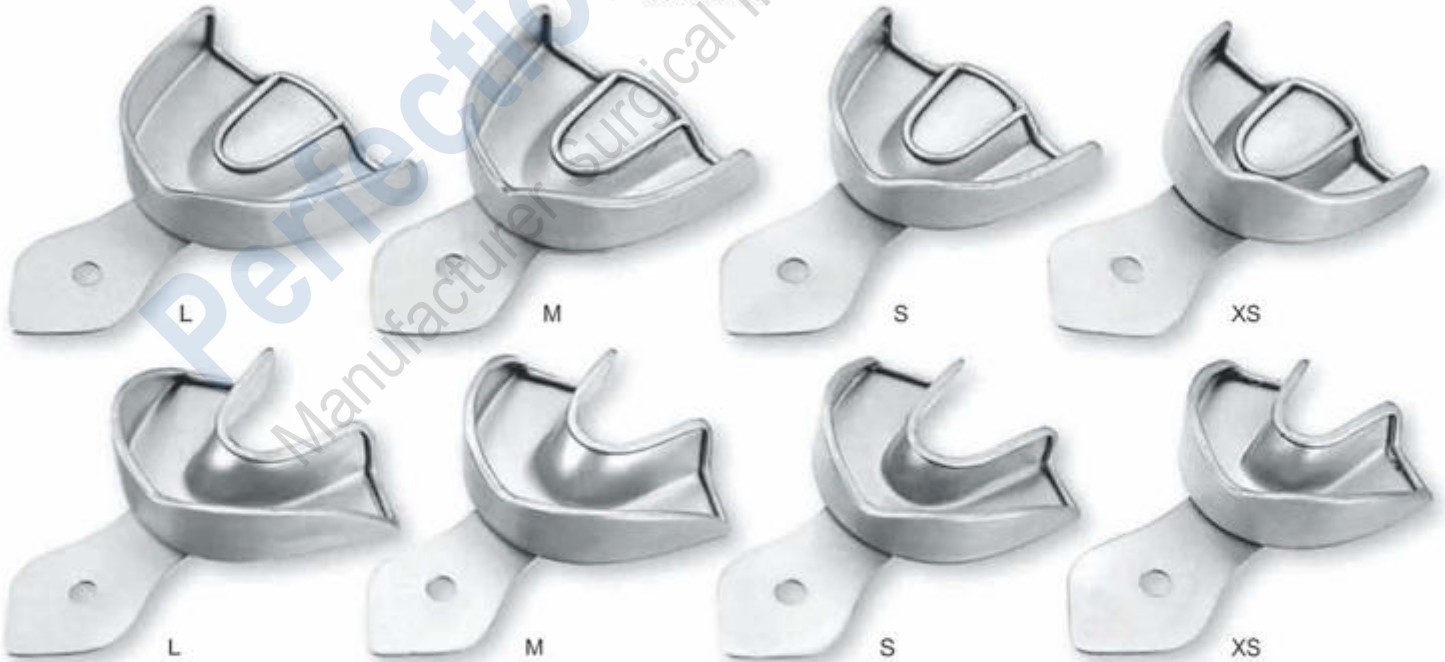

PS-3148 SET OF 08 PCS
Upper: XS, S, M, L
Lower: XS, S, M, L

PS-3149 SET OF 08 PCS
Upper: S, M, L, XL
Lower: S, M, L, XL

PS-3150 SET OF 10 PCS
Upper: XS, S, M, L, XL
Lower: XS, S, M, L, XL

IMPRESSION TRAYS

- Оттисные ложки
 - Porte-empreinte
 - Abdrucklöffel
- Відбиткові ложки
 - Cubetas para impresiones
 - صواني الانطباع

PERFORATED FULL DENTURE

Set of 8 Pcs



PS-3151 SET OF 08 PCS
Upper: S, M, L, XL
Lower: S, M, L, XL

PS-3152 SET OF 08 PCS
Upper: S, M, L
Lower: S, M, L

SOLID FULL DENTURE

Set of 8 Pcs

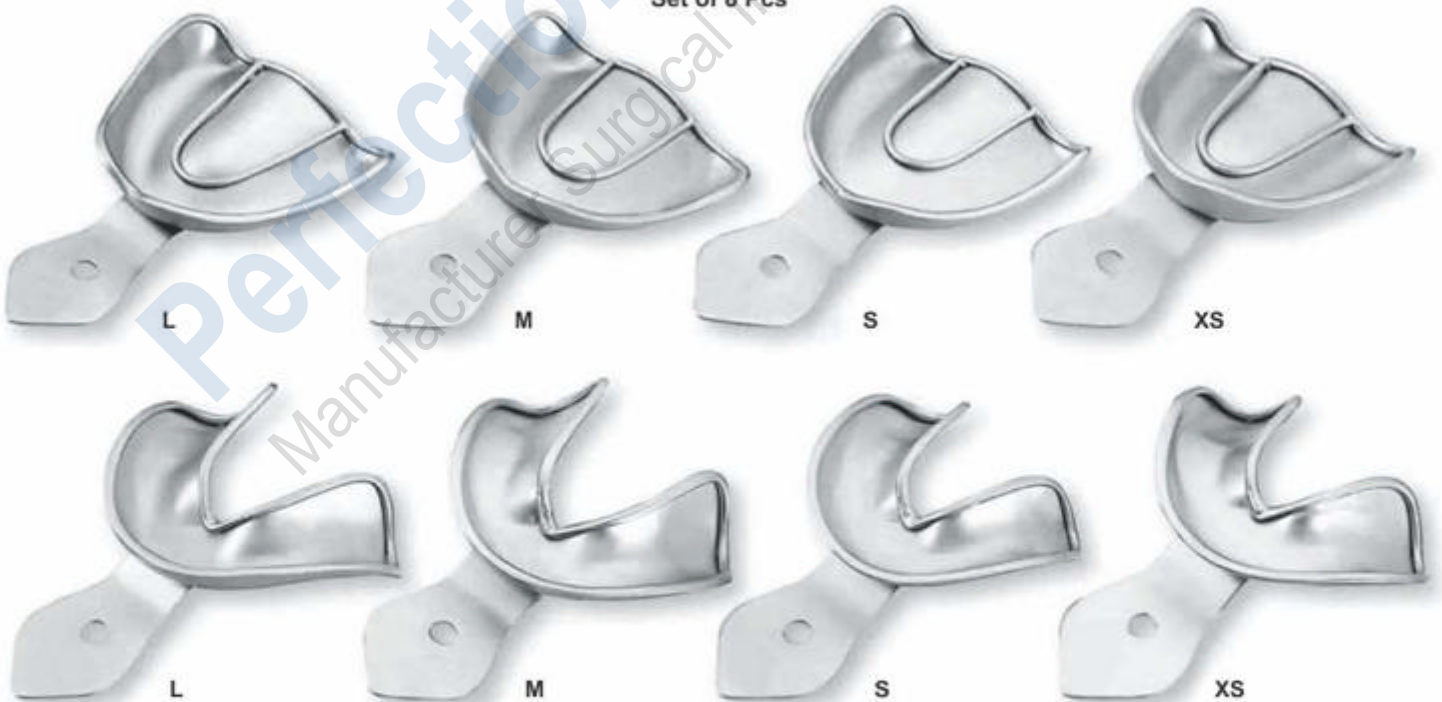

PS-3153 SET OF 08 PCS
Upper: S, M, L, XL
Lower: S, M, L, XL

PS-3154 SET OF 06 PCS
Upper: S, M, L
Lower: S, M, L

IMPRESSION TRAYS



- Оттисные ложки
 - Porte-empreinte
 - Abdrucklöffel
- Відбиткові ложки
 - Cubetas para impresiones
 - صواني الاطباع

Perforated Without Rim Lock

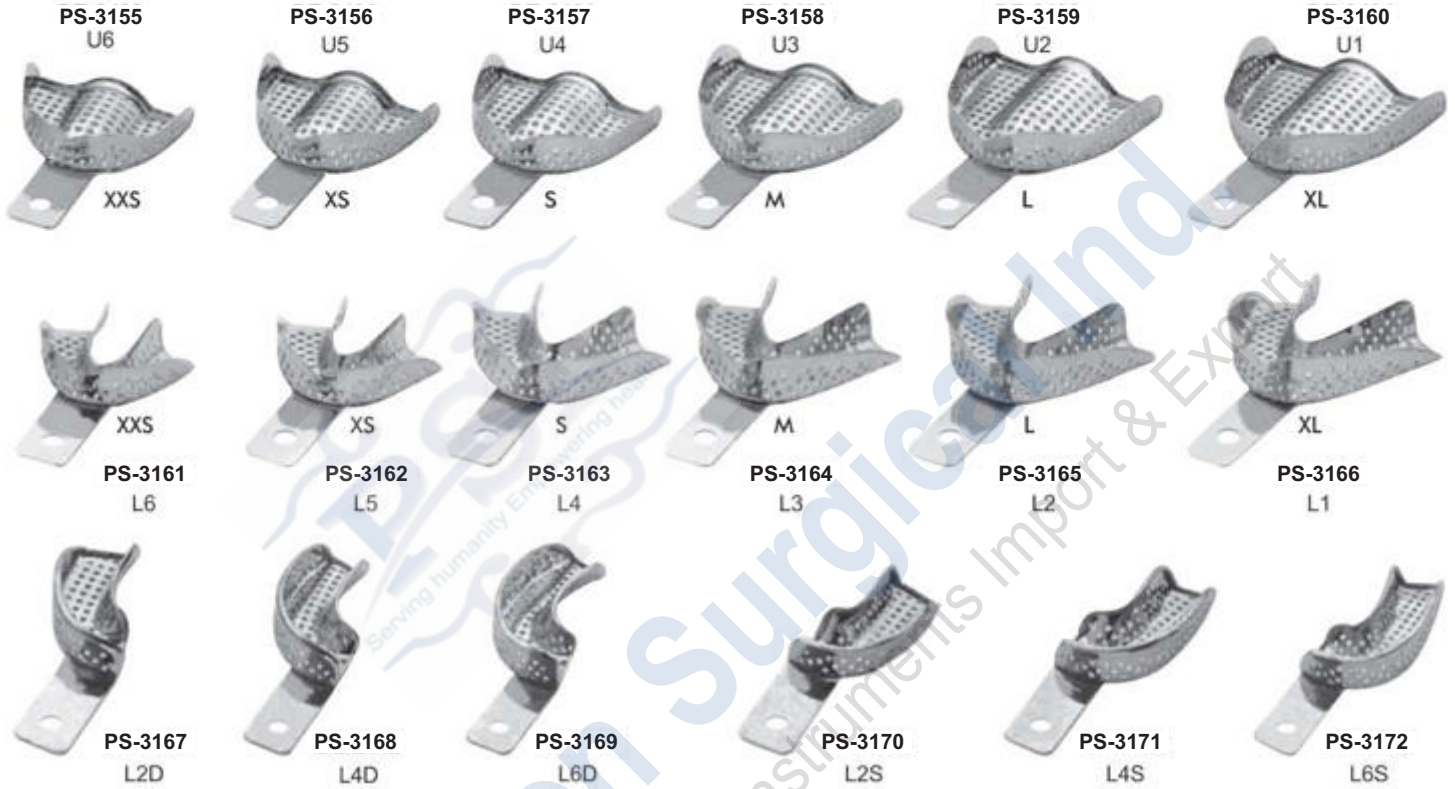

Solid With Rim Lock

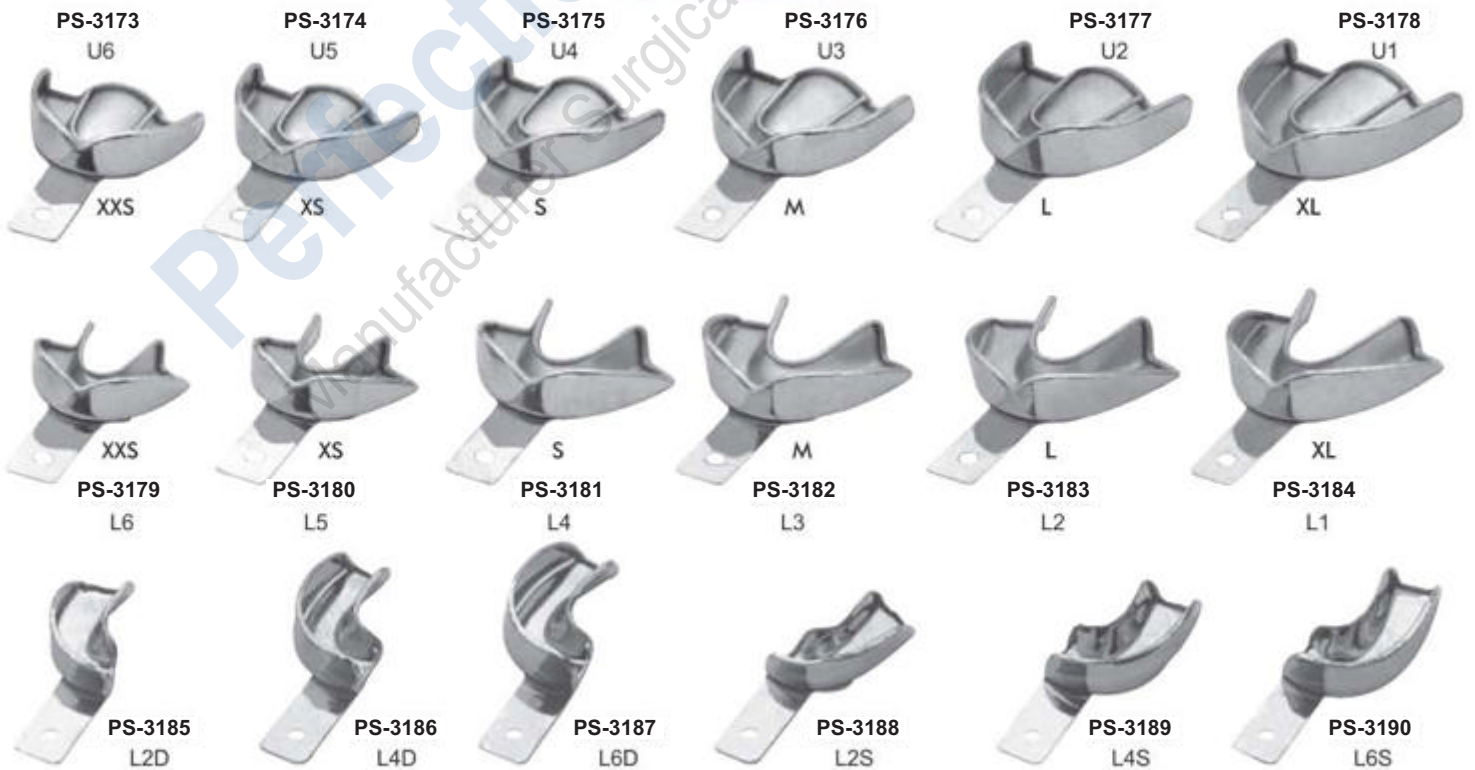



HOLLOWWARE INSTRUMENTS



Scalers Tray
PS-3191 200 x 100 mm



Scalers Trays
PS-3192 205 x 115 x 17 mm
PS-3193 205 x 152 x 17 mm
PS-3194 290 x 115 x 17 mm



Instruments Trays
PS-3195 200 x 110 x 30 mm
PS-3196 215 x 115 x 35 mm
PS-3197 220 x 130 x 30 mm
PS-3198 230 x 125 x 35 mm
PS-3199 245 x 140 x 40 mm
PS-3200 285 x 160 x 45 mm
PS-3201 315 x 175 x 50 mm
PS-3202 330 x 185 x 50 mm



Instruments Trays
PS-3203 150 x 100 x 50 mm
PS-3204 200 x 100 x 50 mm
PS-3205 220 x 120 x 50 mm
PS-3206 240 x 140 x 50 mm
PS-3207 200 x 150 x 50 mm
PS-3208 250 x 200 x 50 mm
PS-3209 300 x 250 x 50 mm
PS-3210 300 x 200 x 50 mm
PS-3211 350 x 250 x 50 mm
PS-3212 400 x 300 x 50 mm
PS-3213 450 x 300 x 50 mm
PS-3214 450 x 350 x 50 mm



Instruments Trays With Lid
PS-3215 150 x 100 x 50 mm
PS-3216 200 x 100 x 50 mm
PS-3217 220 x 120 x 50 mm
PS-3218 240 x 140 x 50 mm
PS-3219 200 x 150 x 50 mm
PS-3220 250 x 200 x 50 mm
PS-3221 300 x 250 x 50 mm
PS-3222 300 x 200 x 50 mm
PS-3223 350 x 250 x 50 mm
PS-3224 400 x 300 x 50 mm
PS-3225 450 x 300 x 50 mm
PS-3226 450 x 350 x 50 mm



Mayo Tray Perforated
PS-3227 150 x 100 x 25 mm
PS-3228 200 x 100 x 25 mm
PS-3229 220 x 120 x 25 mm
PS-3230 240 x 140 x 25 mm
PS-3231 200 x 150 x 25 mm
PS-3232 250 x 200 x 25 mm
PS-3233 300 x 250 x 25 mm
PS-3234 300 x 200 x 25 mm
PS-3235 350 x 250 x 25 mm
PS-3236 400 x 300 x 25 mm
PS-3237 450 x 300 x 25 mm
PS-3238 450 x 350 x 25 mm



Scaler Tray
PS-3239 200 x 115 mm
PS-3240 205 x 150 mm
PS-3241 290 x 150 mm
PS-3242 300 x 200 mm



Instruments Tray Perforated
PS-3243 150 x 100 x 50 mm
PS-3244 200 x 100 x 50 mm
PS-3245 220 x 120 x 50 mm
PS-3246 240 x 140 x 50 mm
PS-3247 200 x 150 x 50 mm
PS-3248 250 x 200 x 50 mm
PS-3249 300 x 250 x 50 mm
PS-3250 300 x 200 x 50 mm
PS-3251 350 x 250 x 50 mm
PS-3252 400 x 300 x 50 mm
PS-3253 450 x 300 x 50 mm
PS-3254 450 x 350 x 50 mm

Sterilizing boxes & instruments Trays



Instruments Box with Hooks

PS-3255	170 x 70 x 30 mm
PS-3256	180 x 80 x 40 mm
PS-3257	200 x 100 x 40 mm
PS-3258	200 x 100 x 50 mm
PS-3259	220 x 120 x 50 mm
PS-3260	250 x 150 x 50 mm
PS-3261	250 x 200 x 50 mm
PS-3262	300 x 150 x 60 mm
PS-3263	300 x 200 x 50 mm
PS-3264	350 x 250 x 50 mm
PS-3265	400 x 200 x 100 mm
PS-3266	450 x 250 x 50 mm



Instruments Box

PS-3267	170 x 70 x 30 mm
PS-3268	180 x 80 x 40 mm
PS-3269	200 x 100 x 40 mm
PS-3270	200 x 100 x 50 mm
PS-3271	220 x 120 x 50 mm
PS-3272	250 x 150 x 50 mm
PS-3273	250 x 200 x 50 mm
PS-3274	300 x 150 x 60 mm
PS-3275	300 x 200 x 50 mm
PS-3276	350 x 250 x 50 mm
PS-3277	400 x 200 x 100 mm
PS-3278	450 x 250 x 50 mm



Instruments Box Perforated

PS-3279	170 x 70 x 30 mm
PS-3280	180 x 80 x 40 mm
PS-3281	200 x 100 x 40 mm
PS-3282	200 x 100 x 50 mm
PS-3283	220 x 120 x 50 mm
PS-3284	250 x 150 x 50 mm
PS-3285	250 x 200 x 50 mm
PS-3286	300 x 150 x 60 mm
PS-3287	300 x 200 x 50 mm
PS-3288	350 x 250 x 50 mm
PS-3289	400 x 200 x 100 mm
PS-3290	450 x 250 x 50 mm



Gloves Box

PS-3291	300 x 150 mm
---------	--------------



Catheters Tray with lid

PS-3292	200 x 60 x 40 mm
PS-3293	200 x 90 x 40 mm
PS-3294	320 x 95 x 50 mm
PS-3295	328 x 90 x 50 mm
PS-3296	365 x 90 x 50 mm
PS-3297	440 x 115 x 50 mm



Box With Filter

PS-3298	100 x 50 mm
PS-3299	250 x 150 mm
PS-3300	150 x 65 mm
PS-3301	200 x 100 mm
PS-3302	300 x 200 mm



Instruments Trays With Cover

PS-3303	210 x 110 x 50 mm
PS-3304	240 x 160 x 50 mm
PS-3305	300 x 180 x 50 mm
PS-3306	360 x 210 x 50 mm
PS-3307	400 x 230 x 55 mm

Instruments Trays Without Cover

PS-3308	210 x 110 x 50 mm
PS-3309	240 x 160 x 50 mm
PS-3310	300 x 180 x 50 mm
PS-3311	360 x 210 x 50 mm
PS-3312	400 x 230 x 55 mm



Instruments Box with lid

PS-3313	170 x 70 x 30 mm
PS-3314	180 x 80 x 40 mm
PS-3315	200 x 100 x 40 mm
PS-3316	200 x 100 x 50 mm
PS-3317	220 x 120 x 50 mm
PS-3318	250 x 150 x 50 mm
PS-3319	250 x 200 x 50 mm
PS-3320	300 x 150 x 60 mm
PS-3321	300 x 200 x 50 mm
PS-3322	350 x 250 x 50 mm
PS-3323	400 x 200 x 100 mm
PS-3324	450 x 250 x 50 mm

HOLLOWWARE INSTRUMENTS



Kidney Tray
 PS-3325 160 mm
 PS-3326 200 mm
 PS-3327 250 mm
 PS-3328 280 mm
 PS-3329 300 mm



Kidney Tray Shallow
 PS-3335 170 mm
 PS-3336 220 mm
 PS-3337 240 mm



Kidney Tray With Cover
 PS-3330 160 mm
 PS-3331 200 mm
 PS-3332 250 mm
 PS-3333 280 mm
 PS-3334 300 mm



Kidney Tray
 PS-3338 160 mm
 PS-3339 200 mm
 PS-3340 250 mm
 PS-3341 280 mm
 PS-3342 300 mm



Forceps Jars
 PS-3343 30 x 90 mm
 PS-3344 50 x 100 mm
 PS-3345 50 x 130 mm
 PS-3346 50 x 175 mm
 PS-3347 75 x 100 mm
 PS-3348 75 x 130 mm
 PS-3349 75 x 175 mm
 PS-3350 100 x 175 mm
 PS-3351 100 x 200 mm



Methot Jar Without Lid
 PS-3352



Dressing Jar / Cotton Container
 PS-3353 80 x 80 mm
 PS-3354 100 x 60 mm
 PS-3355 100 x 80 mm
 PS-3356 100 x 100 mm
 PS-3357 120 x 80 mm
 PS-3358 120 x 100 mm
 PS-3359 150 x 100 mm
 PS-3360 150 x 150 mm
 PS-3361 180 x 150 mm
 PS-3362 180 x 180 mm
 PS-3363 200 x 200 mm
 PS-3364 240 x 240 mm



Sputum Cup
 PS-3365



Dressing Jar With Lid & Knob
 PS-3366 80 x 80 mm
 PS-3367 90 x 90 mm
 PS-3368 100 x 100 mm
 PS-3369 120 x 120 mm
 PS-3370 100 x 130 mm
 PS-3371 150 x 150 mm
 PS-3372 125 x 170 mm



Round Bowls
 PS-3373 80 x 35 mm
 PS-3374 125 x 60 mm



Spirit Lamp
PS-3375



Spirit Lamp
PS-3376



Spirit Lamp
PS-3377



Cotton Holding Jar
PS-3378



Cotton Holder
PS-3379



Cotton Holder
PS-3380



**Cotton Wool Dispenser Acc.
to Methot**
PS-3381



Needle Sterillization Tub
PS-3382



Round Endodontic Boxes
complete with lid
PS-3383 Ø mm. 94 - h. mm. 70



Endodontic Box
PS-3384

HOLLOWWARE INSTRUMENTS



PS-3385
100 x 180 x 11mm
Mini size



PS-3386
100 x 180 x 11mm
Mini size



PS-3387
100 x 180 x 11mm
Mini size



PS-3388
100 x 180 x 11mm
Mini size



PS-3389
100 x 180 x 11mm
Mini size



PS-3390
103 x 182 x 10mm
Mini size
Lid
Coperchio



PS-3391
Silver



PS-3392 Blue
PS-3393 Red



PS-3394 Blue
PS-3395 Red



PS-3396
Silver



PS-3397
Green



PS-3399
Blue

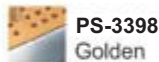

PS-3398
Golden



PS-3400
Red



PS-3401
Silver



PS-3402
Midi
125 x 105 x 54mm



PS-3403
Maxi
204 x 105 x 54mm

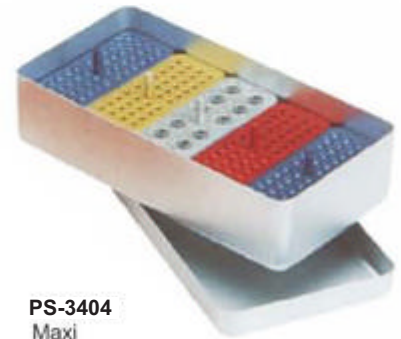

PS-3404
Maxi
204 x 105 x 54mm



Round Sterilizer Drum

PS-3405	mm. Ø 80 x 80 H
PS-3406	mm. Ø 125 x 80 H
PS-3407	mm. Ø 125 x 100 H
PS-3408	mm. Ø 125 x 125 H
PS-3409	mm. Ø 150 x 80 H
PS-3410	mm. Ø 150 x 100 H
PS-3411	mm. Ø 150 x 130 H
PS-3412	mm. Ø 150 x 150 H
PS-3413	mm. Ø 150 x 190 H
PS-3414	mm. Ø 190 x 125 H
PS-3415	mm. Ø 190 x 145 H
PS-3416	mm. Ø 190 x 165 H
PS-3417	mm. Ø 190 x 190 H
PS-3418	mm. Ø 190 x 240 H
PS-3419	mm. Ø 190 x 290 H
PS-3420	mm. Ø 240 x 120 H
PS-3421	mm. Ø 240 x 145 H
PS-3422	mm. Ø 240 x 165 H
PS-3423	mm. Ø 240 x 190 H
PS-3424	mm. Ø 240 x 240 H
PS-3425	mm. Ø 240 x 290 H
PS-3426	mm. Ø 240 x 340 H
PS-3427	mm. Ø 240 x 390 H
PS-3428	mm. Ø 290 x 145 H
PS-3429	mm. Ø 290 x 165 H
PS-3430	mm. Ø 290 x 190 H
PS-3431	mm. Ø 290 x 240 H
PS-3432	mm. Ø 290 x 290 H
PS-3433	mm. Ø 290 x 340 H
PS-3434	mm. Ø 290 x 390 H
PS-3435	mm. Ø 340 x 145 H
PS-3436	mm. Ø 340 x 165 H
PS-3437	mm. Ø 340 x 190 H
PS-3438	mm. Ø 340 x 240 H
PS-3439	mm. Ø 340 x 290 H
PS-3440	mm. Ø 340 x 340 H
PS-3441	mm. Ø 340 x 390 H
PS-3442	mm. Ø 390 x 140 H
PS-3443	mm. Ø 390 x 165 H
PS-3444	mm. Ø 390 x 190 H
PS-3445	mm. Ø 390 x 240 H
PS-3446	mm. Ø 390 x 290 H
PS-3447	mm. Ø 390 x 340 H
PS-3448	mm. Ø 390 x 390 H
PS-3449	mm. Ø 390 x 490 H

Round Sterilizer Drums "Filter"

PS-3450	mm. Ø 80 x 80 H
PS-3451	mm. Ø 125 x 80 H
PS-3452	mm. Ø 125 x 100 H
PS-3453	mm. Ø 125 x 125 H
PS-3454	mm. Ø 150 x 100 H
PS-3455	mm. Ø 150 x 130 H
PS-3456	mm. Ø 150 x 150 H
PS-3457	mm. Ø 150 x 190 H
PS-3458	mm. Ø 190 x 145 H
PS-3459	mm. Ø 190 x 165 H
PS-3460	mm. Ø 190 x 190 H
PS-3461	mm. Ø 190 x 240 H
PS-3462	mm. Ø 240 x 145 H
PS-3463	mm. Ø 240 x 165 H
PS-3464	mm. Ø 240 x 190 H
PS-3465	mm. Ø 240 x 240 H
PS-3466	mm. Ø 240 x 290 H
PS-3467	mm. Ø 240 x 340 H
PS-3468	mm. Ø 240 x 390 H
PS-3469	mm. Ø 290 x 145 H
PS-3470	mm. Ø 290 x 165 H
PS-3471	mm. Ø 290 x 190 H
PS-3472	mm. Ø 290 x 240 H
PS-3473	mm. Ø 290 x 290 H
PS-3474	mm. Ø 290 x 340 H
PS-3475	mm. Ø 290 x 390 H
PS-3476	mm. Ø 340 x 145 H
PS-3477	mm. Ø 340 x 165 H
PS-3478	mm. Ø 340 x 190 H
PS-3479	mm. Ø 340 x 240 H
PS-3480	mm. Ø 340 x 290 H
PS-3481	mm. Ø 390 x 140 H
PS-3482	mm. Ø 390 x 165 H
PS-3483	mm. Ø 390 x 190 H
PS-3484	mm. Ø 390 x 240 H
PS-3485	mm. Ø 390 x 290 H
PS-3486	mm. Ø 390 x 340 H
PS-3487	mm. Ø 390 x 490 H

Round Bowls With Cover

PS-3488	Ø 40 mm ml.30
PS-3489	Ø 60 mm ml.50
PS-3490	Ø 80 mm ml.150
PS-3491	Ø 100 mm ml.250
PS-3492	Ø 120 mm ml.450
PS-3493	Ø 150 mm ml.750
PS-3494	Ø 180 mm ml.1500
PS-3495	Ø 200 mm ml.2100
PS-3496	Ø 250 mm ml.3500

Round Bowls With Out Cover

PS-3497	Ø 40 mm ml.30
PS-3498	Ø 60 mm ml.50
PS-3499	Ø 80 mm ml.150
PS-3500	Ø 100 mm ml.250
PS-3501	Ø 120 mm ml.450
PS-3502	Ø 150 mm ml.750
PS-3503	Ø 180 mm ml.1500
PS-3504	Ø 200 mm ml.2100
PS-3505	Ø 250 mm ml.3500

HOLLOWWARE INSTRUMENTS



INSTRUMENTS MANAGEMENT SYSTEM

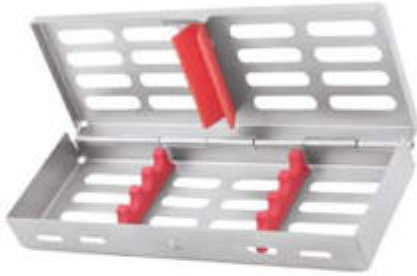

Cassette For 4 Instruments
PS-3506



Cassette For 5 Instruments
PS-3507

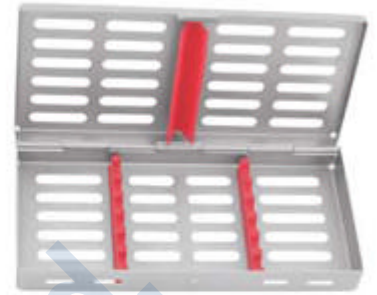

Cassette For 6 Instruments
PS-3508



Cassette For 7 Instruments
PS-3509



Cassette For 10 Instruments
PS-3510



Cassette For 20 Instruments
PS-3511



Cassette For Extraction Forceps
PS-3512



Cassette For Root Elevator
PS-3513



PS-3514
Cassette Tray
15 Pcs



PS-3515
Cassette Tray
15 Pcs

STERILIZING MESH TRAY

Different sizes & dimensions are available at buyer's demand



MESH TRAYS
PS-3516
Different sizes & dimensions are available at buyer's demand

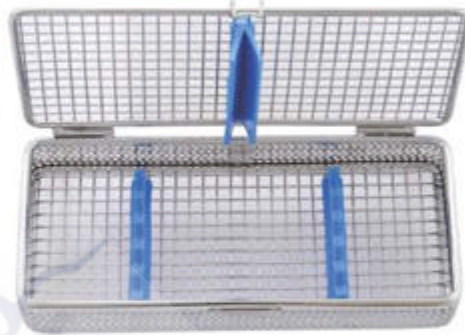

MESH TRAYS
PS-3517
05 Pcs



MESH TRAYS
PS-3518
07 Pcs



MESH TRAYS
PS-3519
10 Pcs



MESH TRAYS
PS-3520
20 Pcs



PS-3521
Mesh Cassettes
5 Pieces, 7 Pieces, 10 Pieces, 15 Pieces & 20 Pieces

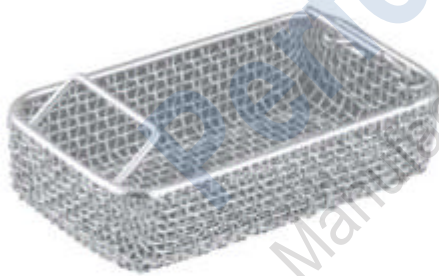

MESH TRAY
PS-3522 240x130x50mm
PS-3523 240x130x60mm
PS-3524 240x250x50mm
PS-3525 240x250x60mm
PS-3526 480x250x50mm
PS-3527 480x250x60mm
PS-3528 480x250x70mm



MESH TRAY
PS-3529 240x250x 50mm
PS-3530 240x250x 60mm
PS-3531 240x250x 70mm
PS-3532 480x250x 50mm
PS-3533 480x250x 60mm
PS-3534 480x250x 70mm
PS-3535 480x250x100mm



MESH TRAY
PS-3536 240x250x50mm
PS-3537 240x250x60mm
PS-3538 240x250x70mm
PS-3539 280x250x50mm
PS-3540 280x250x60mm



MESH TRAY
PS-3541 280x250x 70mm
PS-3542 280x250x100mm
PS-3543 280x250x 50mm
PS-3544 280x280x 60mm
PS-3545 280x280x 70mm
PS-3546 300x280x 60mm

HOLLOWWARE INSTRUMENTS



PS-3547
18×7×3.5cm
5 Instruments Cassette
Detachable Lids
+
5 Instruments Cassette Hinged
Lids with button Lock



PS-3548
29×18.5×3.5cm
20 Instruments Cassette Hinged
Lids with surgical kit fitting,
button lock



Instruments Cassette
PS-3549 5 Pieces Cassette
PS-3550 7 Pieces Cassette
PS-3551 10 Pieces Cassette



PS-3552
18×11×3.5cm
Extra large cassette for 6
Instruments, with compartment
for small parts hinged lids



PS-3553
29×18.5×3.5cm
20 Instruments Cassette
Detachable Lids
+
20 Instruments Cassette Hinged
Lids with button Lock

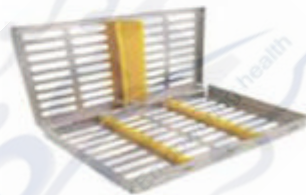

PS-3554
10×13×2.2cm
10 Instruments Cassette Hinged
Lids, Click Lock Available in 2
designs

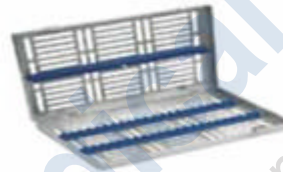

PS-3555
29×18.5×3.5cm
20 Instruments Cassette Detachable
Lids with elevator fitting,
+
20 Instruments Cassette Hinged
Lids with elevator fitting , button lock

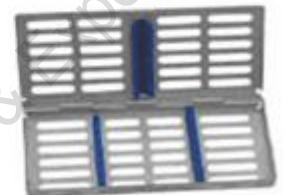

PS-3556
18×9×2.2cm
7 Instruments Cassette Hinged
Lids, Click Lock, Available in 2
designs



PS-3557
21×14×3.5cm
15 Instruments cassette,
Detachable lids, button lock



PS-3558
21×14×3.5cm
15 Instruments cassette,
detachable lids, button
lock, with fitting of micro
surgery kit



PS-3559
21×14×4.5cm
8 pcs luxator/elevator
cassette, Detach0
able lids, button lock



PS-3560
15×9×5cm
Box for dental implant tools and
surgical kits, Capacity:8
tools, 18 tools, 24 Tools, 58 Tools
+ removable compartment



Instruments Tray Perforated
PS-3561 288 x 187 x 40 mm



Instruments Tray Perforated Base
PS-3562 288 x 187 x 40 mm



Instruments Tray Solid Base
PS-3563 288 x 187 x 40 mm



PS-3564 Implant Basic Starter Kit 11 instruments with case



PS-3565 Crown Bridge Set Instruments with Case



PS-3566 Bone Curettes Spoon Style set of 4 with Metal Case



PS-3567 Peritome Set of 2 with Blue Nitrate Tips and Metal Case



PS-3568 Root Fragment Removal elevators, Set of 4 with Metal Case



PS-3569 Peritome Set of 3 Gold Handles Serrated Blades with Metal Case





DESCRIPTION	PAGE#
A	
A COSMETIC CONTOURING IMPLANTOLOGY	148
AB1 BOGHOSIAN IMPLANTOLOGY	147
AB2 BOGHOSIAN IMPLANTOLOGY	147
ABOU-RASS EXPLORERS	54
ACUTE IMPLANTOLOGY	161
ADAMS PLIER	133
ADAMS PLIER ROUND BOX	133
ADAMS PLIERS FOR HOOKS AND BENDING	138
ADAMS, SMALL WIRE BENDING AND LOOP FORMING PLIERS	132
ADERER CLAMP THREE JAW WIRE BENDING PLIER	138
ADERER FACEBOW LOOP FORMING PLIERS	134
ADERER LARGE WIRE BENDING AND LOOP FORMING PLIERS	133
ADERER PLIER	134
ADHESIVE REMOVING PLIERS	36,141
ADSON TX7 CURVED TISSUE FORCEPS	169
ADSON BROWN TWEEZERS	53
ADSON CARBIDE TIPPED TISSUE FORCEPS	169
ADSON NEEDLE HOLDERS	107
ADSON-TC TWEEZERS	53
ADULT PALATAL DENTAL PHOTOGRAPHIC MIRRORS	96
ALLIS HAEMOSTATIC FORCEPS	150
ALLIS-BABY HAEMOSTATIC FORCEPS	150
ALL PURPOSE PLIERS	109
ALUMINUM CALIPER	127
ALM RETRACTOR	162
AMALGAM CARRIERS	117
AMALGAM INSTRUMENTS	118,117
AMALGAM WELL	115,117
ANATOMIC HANDLE EXPLORERS	54
ANDREWS FILLING INSTRUMENTS	87
ANGLE HOW PLIER	139
ANGLED DIRECT BOND BRACKET REMOVER TC	139
ANGLED EXTRACTING FORCEPS FOR UPPER ROOTS	93
ANGLED UTILITY PLIERS	136
ANSWORTH RUBBER DAM CLAMPS FORCEPS	111
ANTERIOR	58
APEX FORCEPS LOWER ROOT DEEP ROOT PICK	96
APEX FORCEPS LOWER UNIVERSAL DEEP ROOT PICK	95
APEXO ROOT ELEVATORS	29
APICAL RETENTION FORCEPS	31,33
APICAL ROOT ELEVATORS	31,33
ARCH BENDING PLIERS	38,143
ARROW CLASP FORMING PLIERS	139
ARTICULATORS	97
ASPIRATING SYRING	27
ATRAUMATIC TWEEZERS	52
ATRAUMATIC WITH LOCK TWEEZERS	52
B	
BABY TOOTH EXTRACTION FORCEPS SET OF 7 PIECES	56
BACK ACTION FILLING INSTRUMENTS	86
BACKHAUS HAEMOSTATIC FORCEPS	110
BACKHAUS TOWEL CLAMPS	110
BACOLITE HANDLE WAX KNIVES	96
BALL BURNISHERS	71
BALL FILLING INSTRUMENTS	93
BALL SOCKET NOT-PERFORATING AND NOT-DAMAGING	150
BALLACORN FILLING INSTRUMENTS	86
BAND REMOVING PLIERS	32,136
BAND SEATER AUTO CLEAVABLE	129
BAND SEATER AUTO CLEAVABLE ROUND SHAPE	129
BAND SEATER AUTO CLEAVABLE SQUARE SHAPE	129
BAND SEATER AUTO CLEAVABLE TRIANGLE SHAPE	128
BAND SEATING & REMOVING INSTRUMENTS	128
BAND SEATING & REMOVING SILICON GRP	125
BAND SEATING PLIERS	141
BANDS & CROWNS PLIER	134
BARRAQUER TC NEEDLE HOLDERS	109
BASINS FOR BONE	174
BAUMGARTNER NEEDLE HOLDERS	96,107
BAYONET ROOTS ELEVATOR SET	36
BEAVERTAIL FILLING INSTRUMENTS	88
BEEBEE GUM SCISSORS	106
BEERENDONK CALIPER	127
BEIN ROOT ELEVATORS	29,40
BENDING PLIER	138
BESEK COMPOSITE INSTRUMENTS	72
BESEK COMPOSITE MODELLING INSTRUMENTS	85
BESEK COMPOSITE PLUGGERS INSTRUMENTS	82
BESEK PLUGGERS	76
BEYER BONE ROUNDER	25
BNANGLE SCALER	67
BIRD BEAK PLIER	38,141
BIRD BEAK PLIER FOR BENDING	138
BIRD BEAK PLIER STANDARD	133
BIRD BEAK WIRE BENDING & CUTTING PLIERS	134
BIRD BEAK WIRE BENDING PLIER	133
BISHOP RETRACTORS	101
BLACK FILLING INSTRUMENTS	80,87
BLACK SCALER	66
BLACK TITANIUM COLOUR COATED INSTRUMENTS	147,148,149
BLADE AND PUSHER	166
BLUE TITANIUM COATED BONE GRAFTING INSTRUMENTS	59,187
SET OF 7 PCS WITH CASSETTE	159
BLUMENTHAL BONE ROUNDER	25
BOLEY GAUGE	127
BONE BRACKET GAUGE	125
BONE CARRIER TITANIUM	150
BONE CRUSHER	174
BONE CRUSHER TITANIUM METAL CUTTER	174
BONE EXPANDER KIT	178
BONE EXPANDER SCREW & SURGICAL KITS	178
BONE FILES	119
BONE GRAFT	158
BONE GRAFT IMPLANTOLOGY	156
BONE GRAFT PACKER	164
BONE GRAFT/CARRIER TITANIUM	167
BONE GRAFTING INSTRUMENTS COMPACTOR /TAMPERS	166
BONE INJECTORS, COLLECTORS & SUCTION TUBE	173
BONE MILL	174
BONE ROUNDER	25
BONE SCRAPER	173
BONE SCRAPER STRAIGHT & CURVED	173
BONE SPOON PACKER	166

DESCRIPTION	PAGE#
BONE THICKNESS GAUGE	146
BONE UNIVERSAL KIT	175
BONE WELL	174
BOX FOR DENTAL IMPLANT TOOLS AND SURGICAL KITS	191
BOX JOINT PLIERS	132,133,134
BRACKET HOLDER TWEEZERS	128
BRACKET PLACER TWEEZERS	128
BRACKET PLACING TWEEZERS	128
BRACKET REMOVING PLIER CURVED	132
BRACKET REMOVING PLIER ROUND BOX	132
BRACKET REMOVING PLIERS ANGLED	136
BRACKET REMOVING PLIERS STRAIGHT	138
BRACKET REMOVING PLIERS WITH PLASTIC TIP	138
BRACKET TWEEZERS SLOT ALIGNER	128
BREWER RUBBER DAM CLAMPS FORCEPS	111
BRUENINGS RETRACTORS	101
BUCCAL AND LINGUAL/PALATAL SCALER	61
BUCCAL DENTAL PHOTOGRAPHIC MIRRORS	98
BUCCAL SURFACES SCALER	61
BUCCAL-SMALL DENTAL PHOTOGRAPHIC MIRRORS	98
BURNISHER FILLING INSTRUMENTS	78,88
BURNISHERS	149
BURNISHERS CONSERVATIVE TREATMENT	68,71
BUSER PERIODONTAL INSTRUMENTS	121
C	
COSMETIC CONTOURING IMPLANTOLOGY	148
CARBIDE DIAMOND COATED POINT	24
CARRY FORCEPS	170
CARVER COMPOSITE MODELLING INSTRUMENTS	85
CARVERS INSTRUMENTS	89,90
CARVERS INSTRUMENTS CASSETTE FOR 5 INSTRUMENTS	90
CASSETTE FOR INSTRUMENTS	162
CASTROVIEJO CALIPERS	126
CASTROVIEJO GUM SCISSORS	105
CASTROVIEJO MICRO SCISSORS	108
CASTROVIEJO NEEDLE HOLDERS	107,108
CATHETERS TRAY WITH LID BOX WITH FILTER	184
CATRIDGE SYRING	27
CEMENT SPATULAS	95
CERI SAW	124
CHEEK RETAINER	101
CHILD PALATAL DENTAL PHOTOGRAPHIC MIRRORS	98
CHIP BLOWER	116
CHISELS, BONE FILES & SPOON CURETTE	116
CHISELS SCALER	65,67
CHOMPRET ROOT ELEVATOR	42
CINCH BACK / TIE BACK DISTAL END BENDING PLIERS	137
CLAW LIFT ROOTS ELEVATOR	37
COARSE SUCTION TUBES	178
COBRA IMPLANTOLOGY	156
COHEN UNIVERSAL EXTRACTING FORCEPS (AMERICAN PATTERN)	17
COLLEGE FORCEPS	51
COLLEGE TWEEZER	53
COLLEGE WITH LOCK TWEEZERS	52
COLLINS-TONGUE FORCEPS	110
COLUMBIA RETRACTOR	99
COMBINATION RETRACTORS	101
COMELAS FORCEPS ANATOMICAL HANDLE	36
COMPASSO DE WILLIS	127
COMPOSITE BALL PLUGGERS	76
COMPOSITE FILLING INSTRUMENTS	92,93
COMPOSITE FILLING INSTRUMENTS SET OF 6 PCS	93
COMPOSITE GOLD TIP INSTRUMENTS	93
COMPOSITE INSTRUMENTS	72,73
COMPOSITE INSTRUMENTS BLUE TITANIUM WITH CASSETTES	89
COMPOSITE INSTRUMENTS TITANIUM BLUE ENDOODONTIC	89
COMPOSITE MODELLING INSTRUMENTS	85
COMPOSITE PLUGGERS INSTRUMENTS	82,83
COMPOSITE/PLASTIC FILLING INSTRUMENTS	87
CONDENSER IMPLANTOLOGY	150,161
CONE-SOCKET MOUTH MIRRORS	49
CONE-SOCKET FRONT SURFACE MOUTH MIRRORS	49
CONE-SOCKET MIRROR HANDLES FOR MOUTH MIRRORS	50
CONE-SOCKET PLAIN MOUTH MIRRORS	49
CONE-SOCKET RHODIUM MOUTH MIRRORS	49
CONE-SOCKET SOLID HANDLES FOR MOUTH MIRRORS	50
CONE-SOCKET SOLID OCTAGONAL HANDLES FOR MOUTH MIRRORS	50
CONTOURING PLIER	134,138
COPERCHIO HOLLOWARE INSTRUMENTS	187
CORROSION-RESISTANT	145
COTTON HOLDER	186
COTTON HOLDING JAW	186
COTTON WOOL DISPENSER ACC. TO METHOT	186
COUPLAND ROOT ELEVATORS	34
CRANE KAPLAN TWEEZERS	53
CRILE-WOOD NEEDLE HOLDERS	106,107
CROWN REMOVER	114
CROWN SPREADERS	114
CRUCIBLE TONGS	124
CRYSER EXTRACTING FORCEPS (AMERICAN PATTERN)	12,13,19,20
CRYSER ROOT ELEVATORS	32
CUTTER	139,142
CUTTER, UTILITY PLIERS & WIRE FORMING PLIERS	141
D	
DEAN GUM SCISSORS	105
DEBAKEY ATRAUMATIC TISSUE FORCEPS	169
DELUX BOLEY GAUGE	127
DELUXE BRACKET HOLDER	128
DELUXE BRACKET HOLDER TWEEZERS	128
DENHARD RETRACTORS - MOUTH GAGS	103
DENTAL PHOTOGRAPHIC MIRRORS	98
DENTAL SYRINGES	27
DENTAURUM CALIPER	127
DERF NEEDLE HOLDERS	106,107
DETAILING STEP PLIER	139
DETAILING STEP PLIERS / BAYONET BENDING PLIERS	137
DIAMOND COATED MARGIN TRIMMERS	65
DIRECT BOND BRACKET HOLDER TWEEZERS	128
DIRECT BOND BRACKET HOLDER TWEEZERS, SMALL TIP	128
DIRECT BONDING BRACKET HOLDERS	128
DIRECT BRACKET REMOVER TC	140
DISC SYSTEM DENTAL SYRINGES	27
DISSECTING SET SET OF 11 PCS	94
DISSECTING SET SET OF 9 PCS	94

DESCRIPTION	PAGE#	DESCRIPTION	PAGE#
DISTAL AMALGAM CARRIERS	117	HAMMER HEAD DISTAL END BENDING PLIERS	137
DISTAL BENDER SILICON GRIP	129	HAMMER WITH WOODEN HANDLE	124
DISTAL CUTTER	139	HANDLE ROUND HANDLES FOR MOUTH MIRRORS	50
DISTAL END CUTTER	135	HANDLES FOR MOUTH MIRRORS	50
DISTAL END CUTTER FLUSH CUT	142	HARD WIRE CUTTER	142
DISTAL END CUTTER, SAFETY HOLD PLIER (IDEAL FOR CUTTING WIRE) TC	140	HARD WIRE CUTTER STRAIGHT	142
DISTAL END WIRE CUTTERS & BRACKET REMOVER PLIERS	140	HARD WIRE CUTTER, 15° ANGLED	135
DISTAL SCALER	81,83	HARD WIRE CUTTER, 15° ANGLED NON-AUTOCALIBRABLE	135
DOUBLE ENDED CEMENT SPATULA	131	HARD WIRE CUTTER, STRAIGHT	140
DOUBLE ROUNDED JAW BENDING PLIERS	138	HARD WIRE CUTTERS	140
DOUBLE ENDED EXPLORERS	54	HARRIS EXTRACTING FORCEPS (AMERICAN PATTERN)	13,18
DRESSING TWEEZERS	52,53	HARTMANN (BABY MOSQUITO) NEEDLE HOLDERS	107
DYNAMOMETER	148	HEAT CARRIERS	57
E		HEBER BAYONET ROOTS ELEVATOR	40
EASY ACCESS TWEEZERS	128	HEBER ROOTS ELEVATOR	40
EBNETER SCALER	84	HEIDBRINK ROOT APPEX ELEVATOR	44
ELASTIC INSTRUMENT SILICON GRIP	129	HEIDBRINK ROOT ELEVATORS	33,43
ELASTIC SEPARATING PLIER	140	HEIDBRINK ROOTS ELEVATOR WARWICK-JAMES	44
ELASTIC SEPARATING PLIER ROUND HANDLE	140	HEIDEMANN FILLING INSTRUMENTS	93
ELASTOMERIC LIGATURE PLACING FORCEPS WITH GROOVE FALCON	140	HEIDEMANN SPATULAS	73
ELEVATORS SET OF 8 PCS	46	HEIGHT GAUGE 0.18 STAINLESS STEEL	125
ELEVATORS SET OF 8 PCS	46	HEIGHT GAUGE ALUMINUM	125
ELLIOT SIGVELAND RETAINERS	115	HEMINGWAY TWEEZERS	53
ENDO FINGER RULER SPAN MEASURE SCALE	125	HEX TORQUE WRENCH UNIVERSAL	177
ENDODONTIC BOX	186	HEXAGONAL HANDLES FOR MOUTH MIRRORS	50
ENDODONTIC EXPLORER	154	HIRSCHFELD PERIODONTAL INSTRUMENTS	122
ENDODONTICS INSTRUMENTS	58	HRT COMPOSITE MODELLING INSTRUMENTS	85
ERGO GRIP RETRACTOR	101	HRT COMPOSITE PLUGGERS INSTRUMENTS	83
EURO BREACH LOADING DENTAL SYRINGES	27	HRT SCALER	86
EXCAVATORS EXPLORERS	51	HMG HEISTER	99
EXCAVATOR INSTRUMENTS	74	HOLLENBACK FILLING INSTRUMENTS	80,87
EXCAVATORS	80	HOLLOW CHOP CONTOURING PLIERS	143
EXECT BRACKET HOLDER TWEEZERS	128	HOLLOW HANDLES FOR MOUTH MIRRORS	50
EXPLORERS	81,54,55,56	HOLLOW MIRROR HANDLES FOR MOUTH MIRRORS	50
EXTRACTING FORCEPS (AMERICAN PATTERN)	126,24	HOLLOWWARE INSTRUMENTS	183,184,186,187,190,191
EXTRACTING FORCEPS (ENGLISH PATTERN)	81,100,26	HOLZ SCALER	65
EXTRACTING FORCEPS (ENGLISH PATTERN) SET OF 10 PIECES	87	HOOK CRIMPING PLIER ANGLED STRAIGHT TC	140
EXTRACTING FORCEPS	86	HOOK KNIVES	96
EXTRACTING FORCEPS AMERICAN ADULT SET OF 10 PCS	28	HOPSON FILLING INSTRUMENTS	78
EXTRACTING FORCEPS AMERICAN ADULT SET OF 3 PCS	28	HOW PLIER	132
EXTRACTING FORCEPS CHILDREN PATTERN SET OF 10 PIECES	28	HOW PLIER CURVED	132
EXTRACTING FORCEPS ENGLISH ADULT SET OF 10 PCS	28	HOW PLIERS OFFSET	141
EXTRACTING FORCEPS ENGLISH ADULT SET OF 10 PCS	28	HOW PLIERS STRAIGHT	141
EXTRACTING FORCEPS PEDO SET OF 7 PCS	28	HOW STRAIGHT UTILITY PLIERS	138
EXTRACTING FORCEPS SET	28	HOWARD PERIOSTEEL ELEVATORS	125
EXTRACTING FORCEPS SET OF 10 PIECES	28	HULL EXTRACTING FORCEPS (AMERICAN PATTERN)	19
EXTRACTING FORCEPS SET OF 10 PIECES	28	HYLIN CEMENT SPATULAS	95
EXTRACTING FORCEPS SET OF 10 PIECES	28	HYLIN ROOTS ELEVATOR	39
EXTRACTING FORCEPS SET OF 13 PIECES	28		
EXTRA-FLEX IMPLANTOLOGY	147	I	
F		IMPLANT GAGES	145
FALCON BEAK CONTOURING PLIERS	133,138	IMPLANT SINUS LIFT INSTRUMENTS	161,182
FARABEUF RETRACTORS SET OF 2 PICES)	103	IMPLANTOLOGY	145,178
FELDMAN RETRACTOR	103	IMPLANTOLOGY 8PCS OF SET	181
FILLING INSTRUMENTS (GOLD POINTED)	91	IMPLANTOLOGY SET OF 2 COMPOSITE BLUE TIP INSTRUMENTS	154
FILLING INSTRUMENTS	87,88,91,93	IMPLANTOLOGY SET OF 3 COMPOSITE BLUE TIP INSTRUMENTS	154
FILLING INSTRUMENTS CONSERVATIVE TREATMENT	89,93,95,98,99,81,84	IMPLANTOLOGY SET OF 4 COMPOSITE BLUE TIP INSTRUMENTS	154
FIRST AID EXAMINATION SET OF 3 PICES	51	IMPLANTOLOGY SET OF 5 COMPOSITE GOLD TIP INSTRUMENTS	154
FLEXIBLE PERIOME	163	IMPRESSION TRAYS	179,182
FLEXI THIN IMPLANTOLOGY	147	IMPRESSION TRAYS PERFORATED FULL DENTURE SET OF 8 PCS	181
FLOHR ROOT ELEVATORS	29,33	IMPRESSION TRAYS PERFORATED WITHOUT RIM LOCK	182
FLOUCH-CUT DISTAL AND CUTTING PLIERS	137	IMPRESSION TRAYS SOLID FULL DENTURE SET OF 08 PCS	181
FLOUCH-CUT DISTAL END CUTTER	138	IMPRESSION TRAYS SOLID FULL DENTURE SET OF 8 PCS	182
FOERSTER DRESSING FORCEPS	160	IMPRESSION TRAYS SOLID WITH RIM LOCK	180
FRAZIER SUCTION TUBES WITH FILTER	178	IMPRESSION TRAYS SOLID WITH RIM LOCK SET OF 06 PCS	180
FREEDMAN "DUCKHEAD"	148	IMPRESSION TRAYS SOLID WITH RIM LOCK SET OF 08 PCS	180
FREEDMAN BURNISHERS	148	IMPRESSION TRAYS SOLID WITH RIM LOCK SET OF 10 PCS	180
FREEDMAN LARGE CONTACT FORMING	149	INSTRUMENTS BOX	184
FREEDMAN SMALL CONTACT FORMING	149	INSTRUMENTS BOX PERFORATED	184
FREER PERIODONTAL INSTRUMENTS	121	INSTRUMENTS BOX WITH HOOKS	184
FREER PERIOSTEEL ELEVATORS	120	INSTRUMENTS BOX WITH LID	184
FRET SAW	124	INSTRUMENTS CASSETTE 10 HINGED	191
FRIEDMAN BONE ROUNDER	25	INSTRUMENTS CASSETTE 10 PICES CASSETTE	191
FRIEDMANN ROOT ELEVATOR	36	INSTRUMENTS CASSETTE 15 SURGERY KIT	191
FRIEDMANNRICHARD PERIODONTAL INSTRUMENTS	122	INSTRUMENTS CASSETTE	191
FUZZI COMPOSITE MODELLING INSTRUMENTS	85	INSTRUMENTS CASSETTE 20 DETACHABLE	191
G		INSTRUMENTS CASSETTE 20 DETACHABLE LIDS	191
GERALD TWEEZERS	82	INSTRUMENTS CASSETTE 20 HINGED	191
GILLES TWEEZERS	52	INSTRUMENTS CASSETTE 5 DETACHABLE LIDS	191
GILLES NEEDLE HOLDER WITH SCISSORS	157	INSTRUMENTS CASSETTE 5 HINGED LIDS WITH BUTTON LOCK	191
GLOVES BOX	184	INSTRUMENTS CASSETTE 5 PICES CASSETTE	191
GOLD COLOR SET DENTAL ORAL IMPLANTOLOGY SINUS	158	INSTRUMENTS CASSETTE 7 PICES CASSETTE	191
GOLD MILL (LARGE)	174	INSTRUMENTS TRAY PERFORATED	183,181
GOLD MILL (SMALL)	174	INSTRUMENTS TRAY PERFORATED BASE	191
GOLDMAN FOX SUPER CUT SCISSORS	108	INSTRUMENTS TRAY SOLID BASE	191
GOLDMAN FOX EXPLORERS	55	INSTRUMENTS TRAYS	183
GOLDMAN FOX SCISSORS	108	INSTRUMENTS TRAYS WITH COVER	184
GOLDMAN FOX GUM SCISSORS	104,105	INSTRUMENTS TRAYS WITH LID	183
GOLDMAN FOX PERIODONTAL INSTRUMENTS	121	INSTRUMENTS TRAYS WITHOUT COVER	184
GOLDMANN FOX SCALER	84	INTRALIGAMENTAL ANESTHESIA SYRINGE	27
GRACEY AFTER FIVE	80	IRIS GUM SCISSORS	104
GRACEY CURETTES SCALER	81	IRIS SUPER CUT SCISSORS	108
GRACEY CURETTES	59,63	IRIS GUM SCISSORS	104,105,108
GRACEY MINI FIVE	80	IVORY SIGVELAND RETAINERS	115
GRACEY SCALER	81	IVORY LIGHT WEIGHT RUBBER DAM CLAMPS FORCEPS	111
GRAFT MATERIAL SPOON CONCAVE TIP FOR LARGER GRAFTS	165	IVORY MATRIX RETAINERS	115
GRAFT PACKER	168	IVORY RETRACTORS	101
GRAFT PACKER CONCAVE	168	IVORY RUBBER DAM CLAMPS FORCEPS	111
GRIPPER CARBIDE TIPPED TISSUE FORCEPS TC	169	IVANSON SPRING CALIPER FOR METAL AND PORCELAIN	126
GROTMAN CEMENT SPATULAS	95	IVANSON SPRING CALIPER FOR WAX	126
GROSS MAIER DRESSING FORCEPS	110	J	
GULDENER SCALER	84	JACQUETTE SCALER	83
GUM SCISSORS	104,108	JARABAK PLIERS	143
H		JECT ULTIMA DENTAL SYRINGES	27
HAEMOSTATIC FORCEPS & TOWEL CLAMPS	110	JENNINGS RETRACTORS - MOUTH GAGS	100
HALSEY NEEDLE HOLDERS	106,107	JOHNSON CONTOURING PLIERS	133
HALSTEAD MOSQUITO HAEMOSTATIC FORCEPS	110	JOHNSON PLIERS FOR CROWN BAND CONTOURING	138
HALSTEAD MOSQUITO NEEDLE HOLDERS	107	JONES TOWEL CLAMPS	110
HALTERPINZETTE WITH LOCK TWEEZERS	170	JOSEPH GUM SCISSORS	105
		K	
		KALT NEEDLE HOLDERS T.C	109
		KELLS EXTRACTING FORCEPS (AMERICAN PATTERN)	15



DESCRIPTION	PAGE#
KELLY GUM SCISSORS	104,105
KELLY HAEMOSTATIC FORCEPS	110
KELLY-RANKIN HAEMOSTATIC FORCEPS	110
KEY RINGS	94
KEYS FOR IMPLANT SCREW	177
KILNER (RAGNELL) GUM SCISSORS	105
KIRLAND SCALER	64
KLEIM EXTRACTING FORCEPS	28
KLEIMERT-KUTZ BONE ROUNDER	29
KOPF ROOTS ELEVATOR	39
KRAMER NEVINS SINUS LIFT	162
KRAMER-NEVINS PERIODONTAL INSTRUMENTS	121
KRARNER-NEVINS BONE CHISEL	119
KUEHNE TWEEZERS	130
L	
LA GRANGE NEEDLE HOLDERS	109
LA GRANGE GUM SCISSORS	104,105
LADMORE FILLING INSTRUMENTS	88
LADMORE IMPLANTOLOGY	149
LAGRANGE SCISSORS	108
LAGRANGE SUPER CUT SCISSORS	108
LANGENBECK RETRACTORS	103
LANGER SCALER	63
LAP & L-KEY JOINT PLIERS	139
LARGE FLUSH-CUT DISTAL AND CUTTING PLIERS	133
LAKUTOR ROOT ELEVATORS	30,31
LAKUTOR ROOT ELEVATORS SET OF 8 PCS	38
LE CRON CEMENT SPATULAS	95
LECLUSE BAYONET ROOT ELEVATOR	41
LESSMANN WAX KNIVES	96
LICHTENBERG-RYDER TC NEEDLE HOLDERS	109
LIGATURE FORMING PLIERS	134
LIGATURE INSTRUMENT SILICON GRIP	129
LIGHT WORE BIRD BEAK PLIERS WITH GROOVE	143
LINDO LEVIAN ROOT ELEVATORS	35
LINGUAL / PALATAL ARCH FORMING PLIERS	134
LINGUAL ARCH FORMING PLIERS	143
LINGUAL DENTAL PHOTOGRAPHIC MIRRORS	98
LINGUAL/PALATAL SURFACES SCALER	61
LINGUAL-LARGE DENTAL PHOTOGRAPHIC MIRRORS	98
LIP & CHEEK RETRACTOR	100
L-KEY JOINT PLIERS	139&138
LOCKLIN GUM SCISSORS	105
LONDON COLLEGE TWEEZERS	52
LONDON HOSPITAL	34
LONG IMPLANT DRILLS	178
LOOP FORMING IN FOUR LENGTH	138
LORNAEMOSTATIC FORCEPS	110
LUCAS IMPLANTOLOGY	168
LUER BONE ROUNDER	25
LURS	58
LUXATING ELEVATOR / PERIOTOME	36
LUXATING ELEVATOR WITH PERIOTOME TIP	29
LUXATOR ROOT ELEVATORS	191
LUXATOR/ELEVATOR 8 PCS	46
LUXATORS SET OF 7 PCS	46
LUXATORS SET OF 7 PCS	46
LUXATORS SET OF 8 PCS	40
LUXATOR ROOTS ELEVATOR	48
LUXATORS CURVED ATRAUMATIC LUXATION OF THE TOOTH	48
LUXATORS STRAIGHT ATRAUMATIC LUXATION OF THE TOOTH	48
M	
MAGNIFYING MOUTH MIRRORS	49
MALLET IMPLANTOLOGY	164
MALLETS - PLASTER SHEARS - SAWS & BLADES	124
MANUAL ASPIRATING SYRINGE	27
MANUAL CROWN REMOVERS	114
MARGIN TRIMMERS	66
MARGINAL RIDGE & EMBRASURE SHAPING INSTRUMENT	148
MARKLEY FILLING INSTRUMENTS	93
MARQUETTE CONDENSER	87
MARQUETTE PLUGGERS	87
MARYAM TWEEZERS	53
MATHIEU NEEDLE HOLDERS	107
MATRIX RETAINERS	115
MAVI HOLLOWARE INSTRUMENTS	187
MAYO GUM SCISSORS	106
MAYO NEEDLE HOLDERS	106
MAYO TRAY PERFORATED	106,107
MAYO-HEGAR NEEDLE HOLDERS	106,107
MCCALL SCALER	63
MEAD BONE ROUNDER	25
MEAD NON AUTO CLAVABLE PLASTIC TIPS	119
MEASURING LOOP	128
MEASURING LOOP CASTROVIEJO	128
MEASURING PROBE	145
MEISSNER EXTRACTING FORCEPS	26
MEMBRANE IMPLANTOLOGY	161
MEMBRANE POSITIONING IMPLANTOLOGY	150
MEMBRANE DETACH ELEVATOR	164
MEMBRANE ELEVATOR	164
MEMBRANE TWEEZERS	170
MERRIAM TWEEZERS	52
MERRIT B EXPLORERS	55
MERSON BAND PUSHER	129
MESH CASSETTES 5 PIECES, 7 PIECES, 10 PIECES, 15PIECES & 20 PIECES	190
MESH TRAY	190
MESH TRAYS 05 PCS	190
MESH TRAYS 07 PCS	190
MESH TRAYS 10 PCS	190
MESH TRAYS	190
MESH TRAYS 20 PCS	190
MESIAL SCALER	61
METZENBAUM GUM SCISSORS	104,106
MICRO ADSON 1X2 TISSUE FORCEPS	189
MICRO BOLEY GAUGE STRAIGHT	146
MICRO BOLEY GAUGE TWISTED	146
MICRO IRIS GUM SCISSORS	104
MICRO SURGICAL SCALPEL HANDLE TITANIUM	123
MICRO-FRIEDMAN BONE ROUNDER	25
MICRO-MINI PIN & LIGATURE CUTTER	142
MIDDELBOERF RETRACTORS	103
MILLER BONE FILES	119
MILLER ROOT ELEVATORS	37

DESCRIPTION	PAGE#
MILLER IMPLANTOLOGY	168
MILLER ROOT PLANNING FILES	119
MILLER TWEEZERS	53
MINI DISTAL AMALGAM CARRIERS	117
MINI GAUGE	127
MINI LIGATURE CUTTERS	133
MINI PIN & LIGATURE CUTTER	142
MINI PIN & LIGATURE CUTTER TC	139
MINI-LANGENBECK RETRACTORS	102
MINI-SPATEL BURNISHERS	71
MINNESOTA RETRACTORS	101
MIRROR EXPLORERS	51
MIRROR HANDLE STEM WITH RULE HANDLES FOR MOUTH MIRRORS	50
MISCELLANEOUS PRODUCTS	94
MIXING SPATULA WITH SHOVEL	165
MOLT 9 PERIODONTAL INSTRUMENTS	121
MOLT AUTO CLAVABLE PLASTIC TIPS	119
MONARI COMPOSITE MODELING INSTRUMENTS	80,85
MORTENSON FILLING INSTRUMENTS	80,87
MOUTH MIRROR EXPLORERS	51
MOUTH MIRRORS	49
MOUTH PROPS	94
MOVEABLE HEIGHT GAUGE	125
MSY CEMENT SPATULAS	95
MUELEMANN SCALER	64,85
MULTIFUNCTIONAL METER	145
MULTI-PURPOSE PLIERS	137
N	
NAKAWANI DENTAL LABORATORY INSTRUMENT	97
NANCE LOOP FORMING PLIERS	132,137
NAPKIN HOLDER WITH METAL CHAIN	94
NAPKIN HOLDER WITH PLASTIC CHAIN	94
NARROW SHOVELAND RETAINERS	115
NEEDLE HOLDERS	106&109
NEEDLE STERILIZATION TUB	186
NEUMANN GUM SCISSORS	105
NEVINS EXTRACTING FORCEPS (AMERICAN PATTERN)	14,16
NORMAL HANDLE EXPLORERS	54
NOYES GUM SCISSORS	105
O	
OBTUSE IMPLANTOLOGY	161
OCCUSAL ANATOMY INSTRUMENT	148
OHV PERIOSTEEL ELEVATORS	120
OHV-HEGAR NEEDLE HOLDER WITH SCISSORS	107
OMEGA LOOP FORMING PLIERS	141
ORBAN SCALER	64
ORTHO BAND PUSHER SCALER	131
ORTHO INSTRUMENT	130
ORTHO LIGATURE DIRECTOR SINGLE ENDED	131
ORTHO LIGHT BAND PUSHER SCALER	129
ORTHO LIGHT DOUBLE ENDED LIGATURE	131
ORTHO LIGHT DOUBLE ENDED LIGATURE DIRECTOR	131
ORTHO LIGHT DOUBLE ENDED LIGATURE DIRECTOR SCALER	129,131
ORTHO LIGHT DOUBLE ENDED LIGATURE SCALER	131
ORTHO LIGHT LIGATURE DIRECTOR DOUBLE ENDED	131
ORTHO LIGHT SCALER	130
ORTHO LIGHT SCALER DOUBLE ENDED	130
ORTHO LIGHT SCALER HEAVY	130
ORTHO LIGHT SCALER SINGLE ENDED	131
ORTHO RULER / CONE SOCKET	146
ORTHODONTIC INSTRUMENTS	129&131
ORTHODONTICS PLIERS STANDS	144
ORTHOLITE LIGATURE DIRECTOR SCALER	131
OSTEOMETER MEASURING FORCEPS FOR JAW	146
OSTEOTOME CONVEXES / CONCAVE / CONQUES	171,172
OSTEOTOME CONVEXES / CONCAVE / CONQUES SET OF 5 PIECES	172
P	
P.K. THOMS WAXING INSTRUMENTS KIT	89
P.K. THOMS WAXING INSTRUMENTS SOLID HANDLE	89
PALATAL-ADULT DENTAL PHOTOGRAPHIC MIRRORS	98
PALATAL-ADULT LARGE DENTAL PHOTOGRAPHIC MIRRORS	98
PALATAL-CHILD DENTAL PHOTOGRAPHIC MIRRORS	98
PALMER RUBBER DAM CLAMPS FORCEPS	111
PARNLY EXTRACTING FORCEPS (AMERICAN PATTERN)	16
PARTSCH PERIOSTEEL ELEVATORS	120
PDL ELEVATORS	47,48
PDL ELEVATORS SET OF 7 PCS	47
PDL ELEVATORS SET OF 7 PCS	47
PDL ELEVATORS SET OF 8 PCS	49
PEDIATRIC TOOTH EXTRACTING FORCEPS SET	28
PEET SPLINTER FORCEPS	109
PERFORATED WITH RIM LOCK SET OF 06 PCS	179
PERFORATED WITH RIM LOCK SET OF 10 PCS	179
PERFORATED WITH RIM LOCK SET OF 8 PCS	179
PERIODONTAL CHISELS	118
PERIODONTAL INSTRUMENTS	120&122
PERIODONTAL KNIVES	64
PERIODONTAL PROBES	58
PERIODONTAL PROBESSPREADERS	57
PERIODONTAL SURGERY	162
PERIOSTEEL ELEVATORS	120,154
PERIOTOME ROOTS ELEVATOR	43
PERRY TWEEZERS	52,53
PHYSIC EXTRACTING FORCEPS (AMERICAN PATTERN)	18
PIN & LIGATURE CUTTER	142
PIN & LIGATURE CUTTERS TC	139
PIN HOLDING PLIER TC	140
PIN-TWEEZERS	170
PLAIN MOUTH MIRRORS	49
PLANATOR	89
PLANATOR	89
PLASTER KNIFE	96
PLASTER SHEARS	124
PLASTIC FILLING INSTRUMENTS	83
PLIER STAND PLASTIC	144
PLIER STAND STAINLESS STEEL	144
PLIERS FOR ORTHODONTICS & PROSTHETICS	130&143
PLIERS STAND STAINLESS ROD (ALUMINUM ANODIZED)	144
PLUGGERS/CONDENSERS	56
PLUGGERS/CONDENSERS	87
POSITIONING 3 IMPLANTOLOGY	161

DESCRIPTION	PAGE#	DESCRIPTION	PAGE#
POSITIVE POSITIONER	125	SURGICAL BALL HOOK CRIMPING PLIERS, ANGLED	137
POSTERIOR BAND REMOVING PLIERS - LONG	141	SURGICAL BALL HOOK CRIMPING PLIERS, STRAIGHT	137
POSTERIOR BAND REMOVING PLIERS - SHORT	141	SURGICAL CHISELS	162
POITTS "T-HANDLE" ELEVATOR-LEFT	41	SUTURE PLIERS SUTURE FORCEPS	169
POITTS "T-HANDLE" ELEVATOR-RIGHT	41	SWEDISH TYPE DENTAL SYRINGES	27
PRICHARD PERIODONTAL INSTRUMENTS	121	SYNDESMOTOMES ROOTS ELEVATOR	43
PROBE EXPLORERS	51		
PRONG 3 CLASP ADJUSTABLE PLIER TC	140	T	
Q		TAMPER	169
QUATRO DENTAL SYRINGES	27	TANNER FILLING INSTRUMENTS	89
R		TARTAR REMOVER INSTRUMENTS SOLID HANDLE	87
RASPATOR, PRICHARD	165	TAYLOR SCALER	63
RASPATOR, RASPATORY	120	THICK EXPLORERS	54
RASPATOR, WILLIGER	120	THREE JAW PLIERS	143
RECTANGULAR ARCH BENDING PLIERS	143	TISSUE GRAFT FORCEP SERRATED TEETH	169
RETRACTOR SELDIN	103	TISSUE MEMBRANE FORCEPS	169,170
RETRACTORS - MOUTH GAGS	96,100	TISSUE PUNCH	173
RETRACTORS	101,103	TISSUE PUNCH FORCEPS TO REMOVE TISSUE AFTER USING PUNCH	170
RHODIUM MOUTH MIRRORS	49	TISSUE PUNCH SET OF FIVE PIECES	173
RIBBON RETRACTORS	101	TISSUE PUNCH STRAIGHT & CURVED	173
RIDGE MAPPING DOUBLE CALIPER	140	TISSUE PUNCH WITH PIN SET OF FOUR PIECES	173
RING 2 DENTAL SYRINGES	27	TITANIUM LOCKING PLIER	169
ROCHESTER-KOCHER HAEMOSTATIC FORCEPS	110	TITANIUM PERIOSTEAL ELEVATOR FOR IMPLAN	122
ROCHESTER-PEAR HAEMOSTATIC FORCEPS	110	TOFFLEMIRE-JUNIOR SQUELVAND RETAINERS	115
ROOT CANAL PLUGGER	56	TOFFLEMIRE-SENIOR SQUELVAND RETAINERS	115
ROOT ELEVATOR	296,48	TOMAS EXTRACTING FORCEPS (AMERICAN PATTERN)	17,22
ROOT ELEVATORS SET OF 10 PCS	46	TORONS NEEDLE HOLDERS	109
ROOT FRAGMENT FORCEPS	09,11	TORQUE WRENCH & RATCHET	177
ROOT PICK ELEVATOR WITH GOLD FLEXIBLE POINTS	42	TORQUING PLIERS SET	137
ROOT PLANNING FILES	159	TOWNER-JAQUETTE SCALER	63
ROOT PLANNING FILES & BONE FILES	159	TREPHINE	175
ROOTS SPLINTER FORCEPS	10	TREPHINE DRILL SET OF EIGHT PIECES	175
ROBER-KÖNIG RETRACTORS - MOUTH GAGS	100	TRINOVO HANDLE	167
ROUND AND CONCAVE PLIER	139	TRIO DENTAL SYRINGES	27
ROUND ENDODONTIC BOXES	186	TRIPLE-ANGLED BACK ACTION EXCAVATOR	86
ROUND EXCAVATOR	86	TWEED / ANGEL FORMING AND TORQUING PLIERS	134
ROUND TORQUE WRENCH UNIVERSAL	177	TWEED / ANGEL RECTANGULAR ARCH FORMING AND TORQUING PLIERS	137
ROUTURER EXTRACTING FORCEPS (ENGLISH PATTERN)	03	TWEED / ANGEL RECTANGULAR ARCH FORMING & TORQUING PLIERS	133
ROUTURER EXTRACTING FORCEPS FOR LOWER MOLARS	03	TWEED LOOP FORMING PLIERS	132,133,143
RUBBER DAM CLAMPS	113	TWEEZERS	62,53
RUBBER DAM CLAMPS FORCEPS	111	TWEEZERS EXPLORERS	51
RUBBER DAM CLAMPS KITS	111	TWEL-ON ELASTIC MODULE INSTRUMENT	130
RUBBER DAM FRAME	111	TYPE C DENTAL SYRINGES	27
RUBBER DUM TEMPLATE	112	U	
RULER	127	UNIQUE RETRACTORS	102
RULER WEDGE	127	UNIVERSAL CROWN REMOVER	114
RUSSIAN LONG TISSUE FORCEPS	170	UNIVERSAL CURETTES	63
RUSSIAN TISSUE FORCEPS	170	UNIVERSAL CUT & HOLD DIGITAL END CUTTER	142
RYDER NEEDLE HOLDERS	106,107	UNIVERSAL DOLPHIN STYLE WIRE BENDING & CUTTING PLIERS	132
S		UNIVERSAL EXTRACTING FORCEPS (AMERICAN PATTERN)	22
SAW BLADES	124	UNIVERSAL MINI-ELEVATOR FOR FRAGMENTS	34
SCALER	596,67	UNIVERSAL NEEDLE HOLDERS	106
SCALERS TRAYS	183	UNIVERSITY OF MICHIGAN EXPLORERS	55
SCALPEL HANDLE STRAIGHT	123	UNIVERSITY OF NORTH CAROLINA EXPLORER	55
SCALPEL HANDLES	123	UPPER ROOT ELEVATOR WITH HELICOIDAL TIP	31
SCHLEMMER ROOTS ELEVATOR	37	US ARMY RETRACTORS	102
SCHMOLIN PERIODONTAL INSTRUMENTS	122	UTERINE PLIER WENIGART TC	140
SCHURE BAND SEATER	130	V	
SCHWARZ PLIERS	139	V-BEND STOP	139
SEPARATING ELASTIC PLIER	111	V-BEND STOP PLIER TC	139
SELDEN PERIODONTAL INSTRUMENTS	122	VERNER GALOGE	127
SELDIR ROOT ELEVATORS	28,32	VISTA TUNNELING INSTRUMENTS SET	155
SELF LOCKING GROOVED	86		
SELF-LOCKING TWEEZER	63	W	
SEMKEN TAYLOR TWEEZERS	13	W BARRY ROOTS ELEVATOR	41
SENN MUELLER RETRACTOR	102	WAHL BONE FILES	119
SERRATED PLUGGERS	84	WAKAI HEAT CARRIERS	57
SET OF 5 PIECES	171	WALDSAVHS WIRE BENDING AND CUTTING PLIERS	134
SHEPHERD'S HOOK EXPLORER	54	WANGEN HOLDER	99
SHORT IMPLANT DRILLS	176	WARD FILLING INSTRUMENTS	80
SICKLE SCALERS	63	WATER SYRINGE	116
SIMPLEX RETRACTOR	100	WAX KNIVES	96
SINUS ELEVATOR & MEMBRANE LIFT TIPS	184	WAY 6 ADJUSTABLE ANGLED SCALPEL HANDLE	123
SINUS IMPLANTOLOGY	156,161	WEIDER RETRACTOR	99
SINUS LEFT ELEVATOR & MEMBRANE LIFT TIPS 3 SET OF 7 PCS	164	WEINGART PLIER	139
SINUS LEFT ELEVATOR SET OF 13 PCS	158	WEINGART PLIER MEDIUM	132,134
SINUS LEFT ELEVATOR	151,157	WEINGART PLIERS	141
SINUS LEFT ELEVATOR SET OF 7 PCS WITH CASSETTE	157	WEINGART UTILITY PLIERS	136
SINUS LIFT INSTRUMENT	150,152,161	WEINGART-MINI UTILITY PLIERS	136
SINUSLIFT IMPLANTOLOGY	150,161	WEITLANER RETRACTORS - MOUTH GAGS	100
SQUELVAND RETAINERS	115	WERDELSTAEDT SCALER	67
SLIM WEINGART PLIERS	141	WESTCOTT BURNISHERS	68
SLIPPER TWEEZERS	128	WESTCOTT FILLING INSTRUMENTS	93
SMAHA ELASTOMERIC LIGATURE PLACING FORCEPS	140	WESTON CEMENT SPATULAS	95
SMALL/MEDIUM BALL BURNISHER	149	WHITE BURNISHERS	68
SOFT BRUSHING KIT SET OF 6 PCS	163	WIDE SQUELVAND RETAINERS	115
SOFT WIRE AND LIGATURE CUTTER	135	WILAND SCALER	65
SOFT WIRE AND LIGATURE CUTTER, STANDARD	135	WILKINS/TUFTS EXPLORER	54
SPATULAS	73	WILLIAMS EXPLORERS	55
SPATULAS ROUNDED AND SHARP	72	WILLIAMS FILLING INSTRUMENTS	81
SPECIAL INDEX	124	WINTER EXTRACTING FORCEPS (AMERICAN PATTERN)	12
SPECIAL INOX WAX KNIVES	96	WINTER ROOTS ELEVATOR	41
SPENCER GUM SCISSORS	105	WIRE BENDING & LOOP FORMING PLIERS	132
SPIRIT LAMP	168	WIRE BENDING AND LOOP FORMING PLIERS ANGLED (BIRD BEAK)	136
SPLINTER FORCEPS	167	WISDOM EXTRACTING FORCEPS	03
SPOON AND PUSHER (TRINCH)	139	WISDOM ROOT ELEVATOR	36
STANDARD LIGATURE CUTTER TC	139	WITZEL FORCEPS WITH ANATOMICAL HANDLE SET OF 3 PCS	09
STAR TORQUE WRENCH UNIVERSAL	177	WITZEL FORCEPS WITH GOLD SET OF 3 PCS	09
STERILIZING BOXES & INSTRUMENTS TRAYS	154	WITZEL FORCEPS WITH HOLE AND SCREW PATTERN SET OF 3 PCS	09
STERILIZING MESH TRAY	180	WITZEL ROOT FRAGMENT FORCEPS	09
STERNBERG RETRACTORS	99	WOODEN HANDLE WAX KNIVES	96
STIEGLITZ ROOT FRAGMENTS	10		
STIEGLITZ SPLINTER FORCEPS	10	X	
STOCKES RUBBER DAM CLAMPS FORCEPS	111	X RAY FILM HANGERS	94
STOP PLIERS V-BEND	137		
STRAIGHT DIRECT BOND BRACKET REMOVER TC	140	Y	
STRIP SAW	129	YOUNG TONGUE FORCEPS	110
SUCTION CANNULA KIT WITH 3 NEEDLES	178	YOUNG WIRE BENDING & LOOP FORMING PLIERS	132
SUCTION NEEDLE	178	YOUNGER GOOD SCALER	63
SUCTION PIPE	178		
SUCTION TUBES	178	Z	
SURGICAL TWEEZERS	52	ZAHLE CEMENT SPATULAS	95

NEW EDITION

DENTAL
DENTAL INSTRUMENTS

DENTAL
INSTRUMENTS CATALOGUE



Perfection Surgical Ind.

Manufacturer Surgical Instruments Import & Export

www.perfectionsurgical.com

